

INDOOR UNIT

No. OBH950
 REVISED EDITION-A

SERVICE MANUAL

Models

MSZ-GX06NL - **U1**
MSZ-GX09NL - **U1**
MSZ-GX12NL - **U1**
MSZ-GX15NL - **U1**
MSZ-GX18NL - **U1**
MSZ-GX24NL - **U1**
MSZ-GX30NL - **U1**
MSZ-GX36NL - **U1**

MSY-GX09NL - **U1**
MSY-GX12NL - **U1**
MSY-GX15NL - **U1**
MSY-GX18NL - **U1**
MSY-GX24NL - **U1**
MSY-GX30NL - **U1**
MSY-GX36NL - **U1**

Outdoor unit service manual
 MUZ-GX•NL/NLHZ, MUY-GX•NL Series (OBH951)
 MXZ-D•NL/NLHZ Series (OBH949)



MSZ-GX18/24/30/36NL
MSY-GX18/24/30/36NL



CONTENTS

1. TECHNICAL CHANGES	3
2. SERVICING PRECAUTIONS FOR UNITS USING REFRIGERANT R454B	4
3. PART NAMES AND FUNCTIONS	10
4. SPECIFICATION	12
5. OUTLINES AND DIMENSIONS	15
6. WIRING DIAGRAM	17
7. REFRIGERANT SYSTEM DIAGRAM	19
8. SERVICE FUNCTIONS	20
9. MICROPROCESSOR CONTROL	24
10. TROUBLESHOOTING	33
11. DISASSEMBLY INSTRUCTIONS	50

PARTS CATALOG (OBB950)

Use the specified refrigerant only

Never use any refrigerant other than that specified.

Doing so may cause a burst, an explosion, or fire when the unit is being used, serviced, or disposed of.

Correct refrigerant is specified in the manuals and on the spec labels provided with our products.

We will not be held responsible for mechanical failure, system malfunction, unit breakdown or accidents caused by failure to follow the instructions.

<Preparation before the repair service>

- Prepare the proper tools.
- Prepare the proper protectors.
- Provide adequate ventilation.
- After stopping the operation of the air conditioner, turn off the power-supply breaker and pull the power plug.
- Discharge the capacitor before the work involving the electric parts.

<Precautions during the repair service>

- Do not perform the work involving the electric parts with wet hands.
- Do not pour water into the electric parts.
- Do not touch the refrigerant.
- Do not touch the hot or cold areas in the refrigeration cycle.
- When the repair or the inspection of the circuit needs to be done without turning off the power, exercise great caution not to touch the live parts.

WARNING

- When the refrigerant circuit has a leak, do not execute pump down with the compressor.
- When pumping down the refrigerant, stop the compressor before disconnecting the refrigerant pipes.
The compressor may burst if air etc. get into it.
- When opening or closing the valve below freezing temperatures, refrigerant may spurt out from the gap between the valve stem and the valve body, resulting in injuries.

Revision A:

- MSZ-GX06/09/12/15NL-[U1] and MSY-GX09/12/15NL-[U1] have been added.

1

TECHNICAL CHANGES

MSZ-GX18NL - [U1]

MSY-GX18NL - [U1]

MSZ-GX24NL - [U1]

MSY-GX24NL - [U1]

MSZ-GX30NL - [U1]

MSY-GX30NL - [U1]

MSZ-GX36NL - [U1]

MSY-GX36NL - [U1]

1. New model

MSZ-GX06NL - [U1]

MSZ-GX09NL - [U1]

MSZ-GX12NL - [U1]

MSZ-GX15NL - [U1]

MSY-GX09NL - [U1]

MSY-GX12NL - [U1]

MSY-GX15NL - [U1]

1. New model

Servicing precautions for units using refrigerant R454B



WARNING

This unit uses a flammable refrigerant.

If refrigerant leaks and comes in contact with fire or heating part, it will create harmful gas and there is risk of fire.

Do not use means to accelerate the defrosting process or to clean, other than those recommended by the manufacturer. The appliance should not be stored in a room with continuously operating ignition sources (for example: open flames, an operating gas appliance, or an operating electric heater).

Do not pierce or burn.

Be aware that refrigerants may not contain an odor.

- Maintenance, service and repair operations shall be performed by authorized technician with required qualification.
- Servicing shall be performed only by methods recommended by the manufacturer.
- Refrigerant piping shall be protected from physical damage.
- Field installed piping should be kept to a minimum.
- Compliance with national gas regulations shall be observed.
- All field joints shall be accessible for inspection prior to being covered or enclosed.

⚠️ ⚠️ WARNING

- The mounting height of indoor unit shall be 5.9 ft (1.8 m) or more from the floor. Up to 7.5 ft (2.3 m) is recommended.
- The unit shall be installed in rooms exceed the minimum room area (A_{min}) determined by total refrigerant amount (M).

NOTE: For the corresponding table of the branch box system, refer to the multi-unit installation manual.

SYSTEM WITHOUT BRANCH BOX

M		A_{min}	
[kg]	[lbs, oz]	[m ²]	[ft ²]
0.5	1 1	1.9	21
0.6	1 5	2.3	25
0.7	1 8	2.6	28
0.8	1 12	3.0	33
0.9	1 15	3.4	37
1.0	2 3	3.8	41
1.1	2 6	4.1	45
1.2	2 10	4.5	49
1.3	2 13	4.9	53
1.4	3 1	5.2	56
1.5	3 4	5.6	61
1.6	3 8	6.0	65

M		A_{min}	
[kg]	[lbs, oz]	[m ²]	[ft ²]
1.7	3 11	6.3	68
1.8	3 15	6.8	74
1.9	4 3	7.2	78
2.0	4 6	7.6	82
2.1	4 10	7.9	86
2.2	4 13	8.3	90
2.3	5 1	8.7	94
2.4	5 4	9.1	98
2.5	5 8	9.4	102
2.6	5 11	9.8	106
2.7	5 15	10.2	110
2.8	6 2	10.6	115

1. REFRIGERANT PIPE NITROGEN PRESSURE TEST METHOD

(1) Connect the testing tools.

- Make sure the stop valves are closed and do not open them.
- Add pressure to the refrigerant lines through the service port of the stop valve for GAS.

(2) Do not add pressure to the specified pressure all at once; add pressure little by little.

1. Pressurize to 0.5 MPa (73 psig, 5 kgf/cm²G), wait 5 minutes, and make sure the pressure does not decrease.
2. Pressurize to 1.5 MPa (218 psig, 15 kgf/cm²G), wait 5 minutes, and make sure the pressure does not decrease.
3. Pressurize to 4.15 MPa (601 psig, 41.5 kgf/cm²G) and measure the surrounding temperature and refrigerant pressure.

(3) If the specified pressure holds for 24 Hours and does not decrease, the pipes have passed the test and there are no leaks.

- If the surrounding temperature changes by 1°F (0.5°C), the pressure will change by about 1 psig (0.007 MPa). Make the necessary corrections.

(4) If the pressure decreases in steps (2) or (3), there is a gas leak. Look for the source of the gas leak.

2. Additional refrigerant charge

Additional refrigerant charge

Refrigerant for the indoor units and the extended piping is not included in the outdoor unit when the unit is shipped from the factory. Therefore, charge each refrigerant piping system with additional refrigerant at the installation site. In addition, in order to carry out service, enter the size and length of each liquid pipe and additional refrigerant charge amounts in the spaces provided on the "Refrigerant amount" plate on the outdoor unit.

NOTE:

- When the unit is stopped, charge the unit with the additional refrigerant through the liquid stop valve after the pipe extensions and indoor units have been vacuumized.
- When the unit is operating, add refrigerant to the gas check valve using a safety charger. Do not add liquid refrigerant directly to the check valve.

Refrigerant adjustment *1

Model	MSZ-GX09/12/15NL MSY-GX09/12/15NL	MSZ-GX18/24/30/36NL MSY-GX18/24/30/36NL
Chargeless pipe length A	25 ft (7.5 m)	50 ft (15 m)
Refrigerant adjustment B	0.22 oz/ft (20 g/m)	
Additional refrigerant	Pipe length up to A : No need Pipe length exceeds A : B×(pipe length - A)	

*1 When installing multi units, refer to the installation manual of the multi outdoor unit for unit installation.

3. REFRIGERANT SENSOR INSTALLATION AND REPLACEMENT

- For system with branch box, the refrigerant sensor shall be installed to the indoor unit before turning on the breaker.
The refrigerant sensor is located inside the branch box package or can be ordered separately Parts Number **MAC-100RS-E**.
- When the refrigerant sensor is installed in the indoor unit, the system may stop operation if refrigerant leaks are detected.
- If the refrigerant sensor fails, replace the refrigerant sensor.
- The refrigerant sensor shall only be replaced with manufacturer approved sensor.
- If the refrigerant sensor error occurs even if the sensor is installed, check the cable connection for the sensor side and the main board side.

MSZ-GX06/09/12/15NL

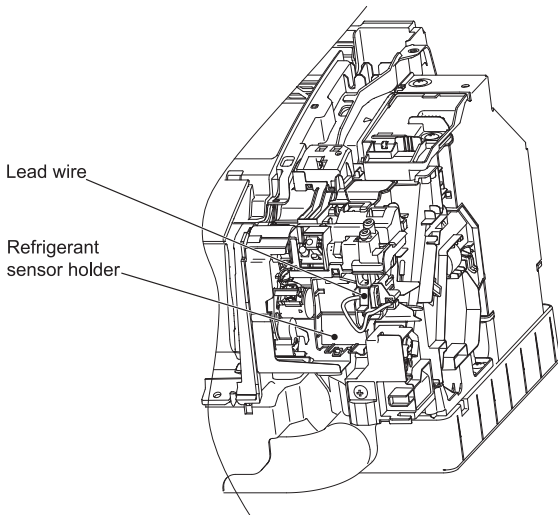

Fig. 1

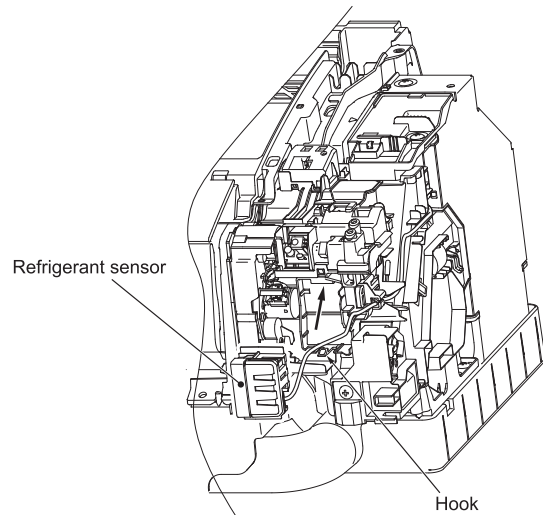

Fig. 2

- (1) Remove the lead wire fixed to the refrigerant sensor holder, then connect it to the refrigerant sensor board. (Fig.1)
Refer to "How to install the Wi-Fi interface" of 11-1. 2. in DISASSEMBLY INSTRUCTIONS.
- (2) Insert the refrigerant sensor in the direction of the arrow and then fix it with the hook. (Fig. 2)

MSZ-GX18/24NL

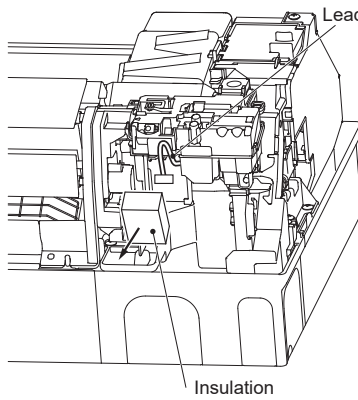

Fig. 1

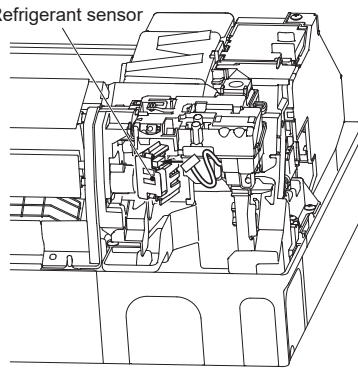

Fig. 2

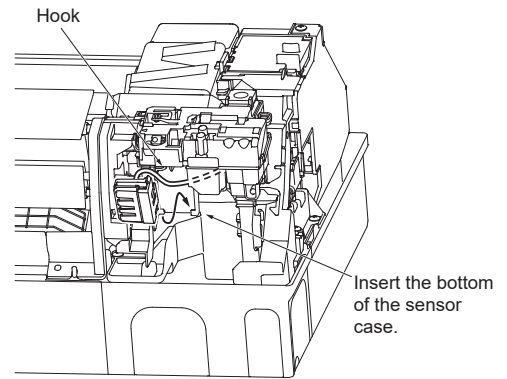

Fig. 3

- (1) Remove the panel.
Refer to "How to install the refrigerant sensor" of 11-2. 3. in DISASSEMBLY INSTRUCTIONS.
- (2) Remove the insulation and take out the lead wire below the insulation. (Fig. 1)
- (3) Connect the lead wire to refrigerant sensor. (Fig. 2)
- (4) Insert the refrigerant sensor in the direction of the arrow and then fix it with the hook. (Fig. 3)

4. Cautions for the unit using R454B refrigerant

Basic work procedures are the same as those for conventional units using refrigerant R410A. However, pay careful attention to the following points.

■ Information on servicing

1. Checks to the area

Prior to beginning work on systems containing FLAMMABLE REFRIGERANTS, safety checks are necessary to ensure that the risk of ignition is minimized. For repair to the REFRIGERATING SYSTEM, 2 to 6 below shall be completed prior to conducting work on the system.

2. Work procedure

Work shall be undertaken under a controlled procedure so as to minimize the risk of a flammable gas or vapour being present while the work is being performed.

3. General work area

All maintenance staff and others working in the local area shall be instructed on the nature of work being carried out. Work in confined spaces shall be avoided.

4. Checking for presence of refrigerant

The area shall be checked with an appropriate refrigerant detector prior to and during work, to ensure the technician is aware of potentially toxic or flammable atmospheres. Ensure that the leak detection equipment being used is suitable for use with all applicable refrigerants, i.e. non-sparking, adequately sealed or intrinsically safe.

5. Presence of fire extinguisher

If any hot work is to be conducted on the refrigerating equipment or any associated parts, appropriate fire extinguishing equipment shall be available to hand. Have a dry powder or CO₂ fire extinguisher adjacent to the charging area.

6. No ignition sources

No person carrying out work in relation to a REFRIGERATING SYSTEM which involves exposing any pipe work shall use any sources of ignition in such a manner that it may lead to the risk of fire or explosion. All possible ignition sources, including cigarette smoking, should be kept sufficiently far away from the site of installation, repairing, removing and disposal, during which refrigerant can possibly be released to the surrounding space. Prior to work taking place, the area around the equipment is to be surveyed to make sure that there are no flammable hazards or ignition risks. "No Smoking" signs shall be displayed.

7. Ventilated area

Ensure that the area is in the open or that it is adequately ventilated before breaking into the system or conducting any hot work. A degree of ventilation shall continue during the period that the work is carried out. The ventilation should safely disperse any released refrigerant and preferably expel it externally into the atmosphere.

8. Checks to the refrigerating equipment

Where electrical components are being changed, they shall be fit for the purpose and to the correct specification. At all times the manufacturer's maintenance and service guidelines shall be followed. If in doubt, consult the manufacturer's technical department for assistance. The following checks shall be applied to installations using FLAMMABLE REFRIGERANTS:

- the actual REFRIGERANT CHARGE is in accordance with the room size within which the refrigerant containing parts are installed;
- the ventilation machinery and outlets are operating adequately and are not obstructed;
- marking to the equipment continues to be visible and legible. Markings and signs that are illegible shall be corrected;
- refrigerating pipe or components are installed in a position where they are unlikely to be exposed to any substance which may corrode refrigerant containing components, unless the components are constructed of materials which are inherently resistant to being corroded or are suitably protected against being so corroded.

9. Checks to electrical devices

Repair and maintenance to electrical components shall include initial safety checks and component inspection procedures. If a fault exists that could compromise safety, then no electrical supply shall be connected to the circuit until it is satisfactorily dealt with. If the fault cannot be corrected immediately but it is necessary to continue operation, an adequate temporary solution shall be used. This shall be reported to the owner of the equipment so all parties are advised.

Initial safety checks shall include:

- that capacitors are discharged: this shall be done in a safe manner to avoid possibility of sparking;
- that no live electrical components and wiring are exposed while charging, recovering or purging the system;
- that there is continuity of earth bonding.

■ Repairs to sealed components

Sealed electrical components shall be replaced.

■ Repair to intrinsically safe components

Intrinsically safe components must be replaced.

■ Cabling

Check that cabling will not be subject to wear, corrosion, excessive pressure, vibration, sharp edges or any other adverse environmental effects. The check shall also take into account the effects of aging or continual vibration from sources such as compressors or fans.

■ Detection of flammable refrigerants

Under no circumstances shall potential sources of ignition be used in the searching for or detection of refrigerant leaks. A halide torch (or any other detector using a naked flame) shall not be used.

The following leak detection methods are deemed acceptable for all refrigerant systems.

Electronic leak detectors may be used to detect refrigerant leaks but, in the case of FLAMMABLE REFRIGERANTS, the sensitivity may not be adequate, or may need re-calibration. (Detection equipment shall be calibrated in a refrigerant-free area.)

Ensure that the detector is not a potential source of ignition and is suitable for the refrigerant used.

Leak detection equipment shall be set at a percentage of the LFL of the refrigerant and shall be calibrated to the refrigerant employed, and the appropriate percentage of gas (25 % maximum) is confirmed.

Leak detection fluids are also suitable for use with most refrigerants but the use of detergents containing chlorine shall be avoided as the chlorine may react with the refrigerant and corrode the copper pipe-work.

If a leak is suspected, all naked flames shall be removed/extinguished.

If a leakage of refrigerant is found which requires brazing, all of the refrigerant shall be recovered from the system, or isolated (by means of shut off valves) in a part of the system remote from the leak.

■ Removal and evacuation

When breaking into the refrigerant circuit to make repairs - or for any other purpose -conventional procedures shall be used. However, for flammable refrigerants it is important that best practice be followed, since flammability is a consideration.

The following procedure shall be adhered to:

- safely remove refrigerant following local and national regulations;
- evacuate;
- purge the circuit with inert gas;
- evacuate;
- continuously flush or purge with inert gas when using flame to open circuit; and
- open the circuit.

The refrigerant charge shall be recovered into the correct recovery cylinders if venting is not allowed by local and national codes.

For appliances containing flammable refrigerants, the system shall be purged with oxygen-free nitrogen to render the appliance safe for flammable refrigerants. This process might need to be repeated several times.

Compressed air or oxygen shall not be used for purging refrigerant systems.

For appliances containing flammable refrigerants, refrigerants purging shall be achieved by breaking the vacuum in the system with oxygen-free nitrogen and continuing to fill until the working pressure is achieved, then venting to atmosphere, and finally pulling down to a vacuum.

This process shall be repeated until no refrigerant is within the system. When the final oxygen-free nitrogen charge is used, the system shall be vented down to atmospheric pressure to enable work to take place.

The outlet for the vacuum pump shall not be close to any potential ignition sources, and ventilation shall be available.

■ Charging procedures

In addition to conventional charging procedures, the following requirements shall be followed.

- Ensure that contamination of different refrigerants does not occur when using charging equipment. Hoses or lines shall be as short as possible to minimize the amount of refrigerant contained in them.
- Cylinders shall be kept in an appropriate position according to the instructions.
- Ensure that the REFRIGERATING SYSTEM is earthed prior to charging the system with refrigerant.
- Label the system when charging is complete (if not already).
- Extreme care shall be taken not to overfill the REFRIGERATING SYSTEM.

Prior to recharging the system, it shall be pressure-tested with the appropriate purging gas. The system shall be leak-tested on completion of charging but prior to commissioning. A follow up leak test shall be carried out prior to leaving the site.

■ Decommissioning

Before carrying out this procedure, it is essential that the technician is completely familiar with the equipment and all its detail. It is recommended good practice that all refrigerants are recovered safely. Prior to the task being carried out, an oil and refrigerant sample shall be taken in case analysis is required prior to re-use of recovered refrigerant. It is essential that electrical power is available before the task is commenced.

- Become familiar with the equipment and its operation.
- Isolate system electrically.
- Before attempting the procedure, ensure that:
 - mechanical handling equipment is available, if required, for handling refrigerant cylinders;
 - all personal protective equipment is available and being used correctly;
 - the recovery process is supervised at all times by a competent person;
 - recovery equipment and cylinders conform to the appropriate standards.
- Pump down refrigerant system, if possible.
- If a vacuum is not possible, make a manifold so that refrigerant can be removed from various parts of the system.
- Make sure that cylinder is situated on the scales before recovery takes place.
- Start the recovery machine and operate in accordance with instructions.
- Do not overfill cylinders (no more than 80 % volume liquid charge).
- Do not exceed the maximum working pressure of the cylinder, even temporarily.
- When the cylinders have been filled correctly and the process completed, make sure that the cylinders and the equipment are removed from site promptly and all isolation valves on the equipment are closed off.
- Recovered refrigerant shall not be charged into another REFRIGERATING SYSTEM unless it has been cleaned and checked.

■ Labelling

Equipment shall be labelled stating that it has been de-commissioned and emptied of refrigerant. The label shall be dated and signed. For appliances containing FLAMMABLE REFRIGERANTS, ensure that there are labels on the equipment stating the equipment contains FLAMMABLE REFRIGERANT.

■ Recovery

When removing refrigerant from a system, either for servicing or decommissioning, it is recommended good practice that all refrigerants are removed safely.

When transferring refrigerant into cylinders, ensure that only appropriate refrigerant recovery cylinders are employed. Ensure that the correct number of cylinders for holding the total system charge is available.

All cylinders to be used are designated for the recovered refrigerant and labelled for that refrigerant (i.e., special cylinders for the recovery of refrigerant). Cylinders shall be complete with pressure-relief valve and associated shut-off valves in good working order.

Empty recovery cylinders are evacuated and, if possible, cooled before recovery occurs.

The recovery equipment shall be in good working order with a set of instructions concerning the equipment that is at hand and shall be suitable for the recovery of the flammable refrigerant.

If in doubt, the manufacturer should be consulted. In addition, a set of calibrated weighing scales shall be available and in good working order. Hoses shall be complete with leak-free disconnect couplings and in good condition.

The recovered refrigerant shall be processed according to local legislation in the correct recovery cylinder, and the relevant waste transfer note arranged. Do not mix refrigerants in recovery units and especially not in cylinders.

If compressors or compressor oils are to be removed, ensure that they have been evacuated to an acceptable level to make certain that FLAMMABLE REFRIGERANT does not remain within the lubricant.

The compressor body shall not be heated by an open flame or other ignition sources to accelerate this process. When oil is drained from a system, it shall be carried out safely.

3

PART NAMES AND FUNCTIONS

MSZ-GX06NL
MSY-GX09NL

MSZ-GX09NL
MSY-GX12NL

MSZ-GX12NL
MSY-GX15NL

MSZ-GX15NL

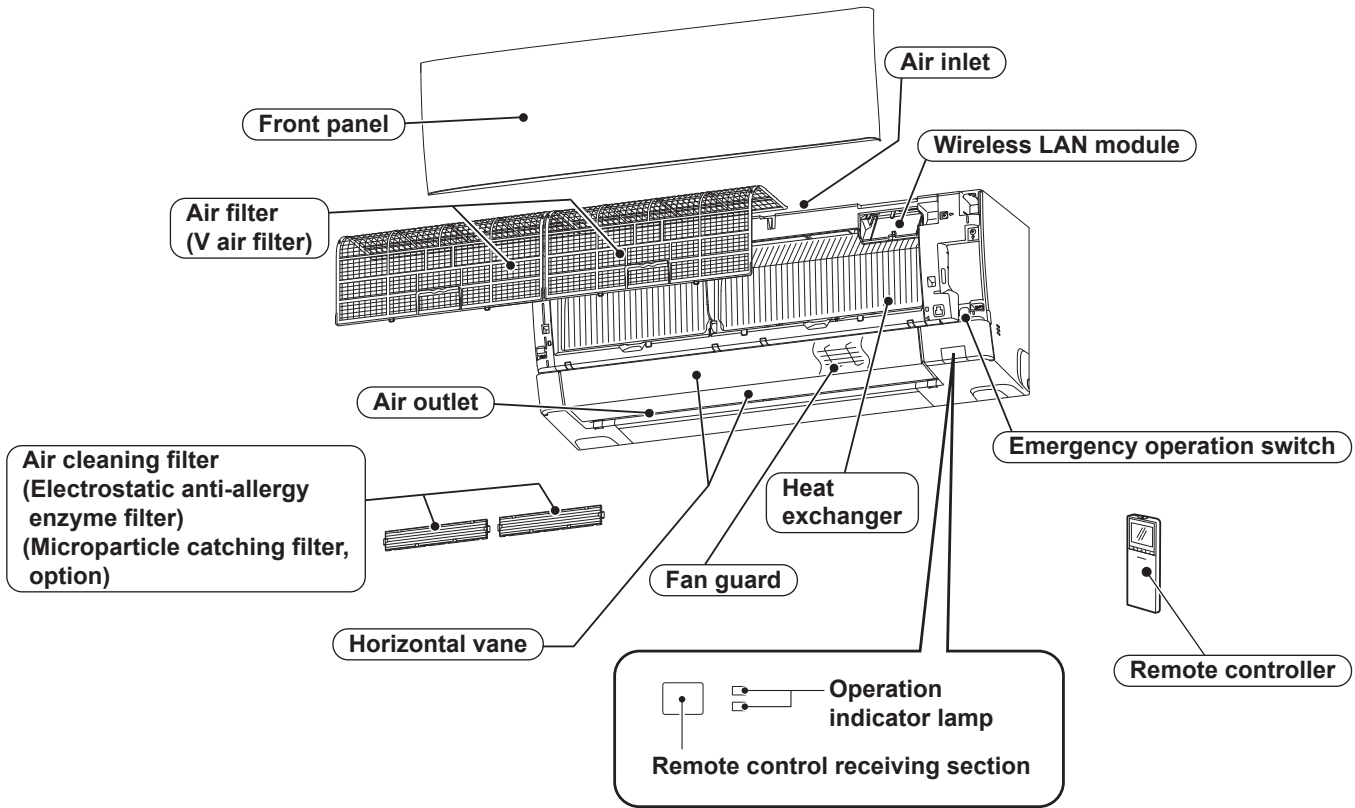

ACCESSORIES

(1)	Installation plate	1
(2)	Installation plate fixing screw 4 × 25 mm	5
(3)	Wireless remote controller	1
(4)	Felt tape (For left or left-rear piping)	1
(5)	Battery (AAA) for (3)	2
(6)	Remote controller holder	1
(7)	Screws for the remote controller holder (6) 3.5 × 16 mm (Black)	2
(8)	Air cleaning filter	2

MSZ-GX18NL MSZ-GX24NL MSZ-GX30NL MSZ-GX36NL
 MSY-GX18NL MSY-GX24NL MSY-GX30NL MSY-GX36NL

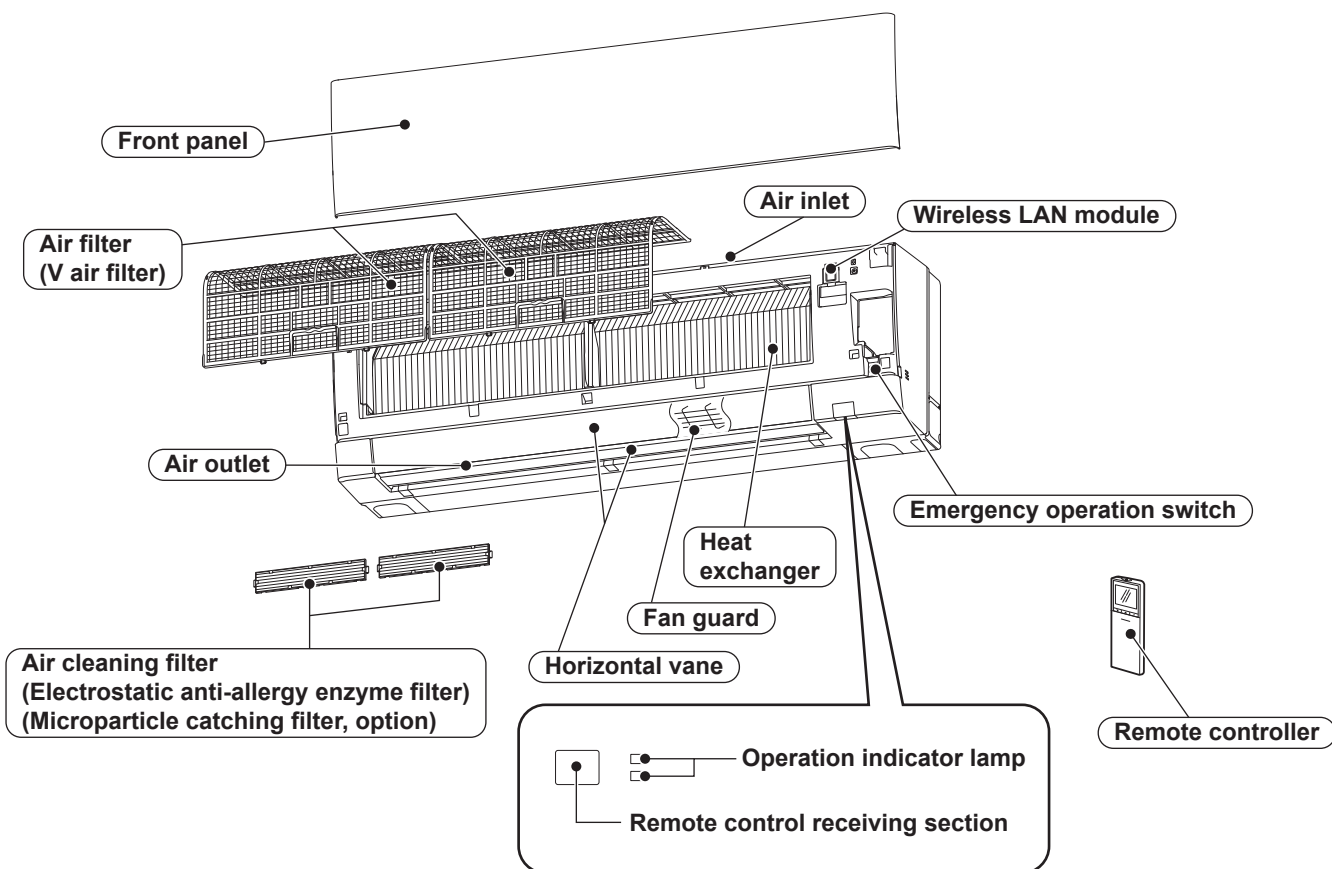

ACCESSORIES

(1)	Installation plate	1
(2)	Installation plate fixing screw 4 × 25 mm	7
(3)	Wireless remote controller	1
(4)	Felt tape (For left or left-rear piping)	1
(5)	Battery (AAA) for (3)	2
(6)	Remote controller holder	1
(7)	Screws for the remote controller holder (6) 3.5 × 16 mm (Black)	2
(8)	Air cleaning filter	2

4

SPECIFICATION

Model		MSZ-GX06NL	MSZ-GX09NL	MSY-GX09NL
Power supply	V, phase, Hz	208/230, 1, 60		
Disconnect switch	A	15		
Min. circuit ampacity	A	1.0		
Fan motor output	hp	0.040		
Airflow Super High - High - Med. -Low -Quiet	COOL Dry (Wet)	CFM	448 - 358 - 256 - 182 - 151 (403 - 323 - 230 - 164 - 136)	
	HEAT Dry		448 - 353 - 256 - 172 - 151 (403 - 318 - 230 - 154 - 136)	—
Moisture removal	pt./h	—	0.8	
Sound level Super High - High - Med. -Low -Quiet	Cooling	dB(A)	—	
	Heating		43 - 37 - 30 - 22 - 19	—
Fan speed Super High - High - Med. -Low -Quiet	Cooling	rpm	1,020 - 860 - 670 - 530 - 470	
	Heating	rpm	1,040 - 860 - 670 - 530 - 470	1,020 - 850 - 670 - 510 - 470
Cond. drain connection O.D.	in.	5/8		
Dimensions	W	in.	31-13/32	
	D		9-21/32	
	H		11-25/32	
Weight	lb.	23		
External finish	Munsell 0.7PB 9.2/0.4			
Remote controller	Wireless type			
Control voltage (by built-in transformer)	12-24 V DC			

NOTE : Test conditions are based on AHRI 210/240.

Model		MSZ-GX12NL	MSY-GX12NL	MSZ-GX15NL	MSY-GX15NL
Power supply	V, phase, Hz	208/230, 1, 60			
Disconnect switch	A	15			
Min. circuit ampacity	A	1.0			
Fan motor output	hp	0.040			
Airflow Super High - High - Med. -Low -Quiet	COOL Dry (Wet)	CFM	448 - 353 - 256 - 172 - 151 (403 - 318 - 230 - 154 - 136)		586 - 465 - 369 - 293 - 219 (528 - 418 - 333 - 264 - 197)
	HEAT Dry		448 - 353 - 256 - 172 - 151	—	516 - 408 - 331 - 266 - 219
Moisture removal	pt./h	2.5		2.3	
Sound level Super High - High - Med. -Low -Quiet	Cooling	dB(A)	45 - 37 - 30 - 22 - 19		51 - 44 - 38 - 32 - 26
	Heating		43 - 37 - 30 - 22 - 19	—	46 - 40 - 35 - 30 - 26
Fan speed Super High - High - Med. -Low -Quiet	Cooling	rpm	1,020 - 850 - 670 - 510 - 470		1,260 - 1050 - 880 - 740 - 600
	Heating	rpm	1,020 - 850 - 670 - 510 - 470	—	1,140 - 950 - 810 - 690 - 600
Cond. drain connection O.D.	in.	5/8			
Dimensions	W	in.	31-13/32		
	D		9-21/32		
	H		11-25/32		
Weight	lb.	23			
External finish	Munsell 0.7PB 9.2/0.4				
Remote controller	Wireless type				
Control voltage (by built-in transformer)	12-24 V DC				

NOTE : Test conditions are based on AHRI 210/240.



Model		MSZ-GX18NL	MSY-GX18NL	MSZ-GX24NL	MSY-GX24NL
Power supply	V, phase, Hz	208/230, 1, 60			
Disconnect switch	A	15			
Min. circuit ampacity	A	1.0			
Fan motor output	hp	0.075			
Airflow Super High - High - Med. -Low -Quiet	COOL Dry (Wet)	650 -530 -454 -392 -324 (585 -477 -408 -353 -292)		765 -636 -454 -392 -324 (688 -573 -408 -353 -292)	
	HEAT Dry	672 -530 -454 -392 -344	—	765 -530 -454 -392 -344	—
Moisture removal	pt./h	3.4		4.5	
Sound level Super High - High - Med. -Low -Quiet	Cooling	49 -44 -38 -33 -28		53 -48 -41 -37 -30	
	Heating	48 -43 -39 -34 -29	—	50 -45 -41 -37 -30	—
Fan speed Super High - High - Med. -Low -Quiet	Cooling	1,140 -970 -860 -770 -670		1,300 -1,120 -860 -770 -670	
	Heating	1,170 -970 -860 -770 -700	—	1,300 -970 -860 -770 -700	—
Cond. drain connection O.D.	in.	5/8			
Dimensions	W	43-5/16			
	D	10-1/8			
	H	12-13/16			
Weight	lb.	37			
External finish		Munsell 0.7PB 9.2/0.4			
Remote controller		Wireless type			
Control voltage (by built-in transformer)		12 -24 V DC			

NOTE : Test conditions are based on AHRI 210/240.

Model		MSZ-GX30NL	MSY-GX30NL	MSZ-GX36NL	MSY-GX36NL
Power supply	V, phase, Hz	208/230, 1, 60			
Disconnect switch	A	15			
Min. circuit ampacity	A	1.0			
Fan motor output	hp	0.075			
Airflow Super High - High - Med. -Low -Quiet	COOL Dry (Wet)	765 -636 -454 -392 -324 (688 -573 -408 -353 -292)		765 -636 -454 -392 -324 (688 -573 -408 -353 -292)	
	HEAT Dry	765 -530 -454 -392 -344	—	765 -530 -454 -392 -344	—
Moisture removal	pt./h	8.3		10.0	
Sound level Super High - High - Med. -Low -Quiet	Cooling	53 -48 -41 -37 -30			
	Heating	50 -45 -41 -37 -30	—	50 -45 -41 -37 -30	—
Fan speed Super High - High - Med. -Low -Quiet	Cooling	1,300 -1,120 -860 -770 -670			
	Heating	1,300 -970 -860 -770 -700	—	1,300 -970 -860 -770 -700	—
Cond. drain connection O.D.	in.	5/8			
Dimensions	W	43-5/16			
	D	10-1/8			
	H	12-13/16			
Weight	lb.	37			
External finish		Munsell 0.7PB 9.2/0.4			
Remote controller		Wireless type			
Control voltage (by built-in transformer)		12 -24 V DC			

NOTE : Test conditions are based on AHRI 210/240.

3-1. OPERATING RANGE

(1) POWER SUPPLY

	Rated voltage	Guaranteed voltage (V)
Indoor unit	208/230 V 1 phase 60 Hz	<p>Min. 187 208 230 Max. 253</p>

(2) OPERATION

Mode	Condition	Intake air temperature (°F)	
		DB	WB
Cooling	Standard temperature	80	67
	Maximum temperature	90	73
	Minimum temperature	67	57
	Maximum humidity	78%	
Heating	Standard temperature	70	60
	Maximum temperature	80	67
	Minimum temperature	70	60

3-2. OUTLET AIR SPEED AND COVERAGE RANGE

Model	Mode	Function	Airflow (CFM)	Air speed (ft./sec.)	Coverage range (ft.)
MSZ-GX06NL	HEAT	Dry	459	23.2	33.2
	COOL	Dry	448	22.6	32.4
		Wet	403	20.4	29.2
MSZ-GX09NL MSY-GX09NL MSZ-GX12NL MSY-GX12NL	HEAT (MSZ)	Dry	448	22.6	32.4
	COOL	Dry	448	22.6	32.4
		Wet	403	20.4	29.2
	MSZ-GX15NL MSY-GX15NL	HEAT (MSZ)	Dry	516	26.1
COOL		Dry	586	29.7	42.1
		Wet	528	26.7	38.0
MSZ-GX18NL MSY-GX18NL	HEAT (MSZ)	Dry	672	28.1	43.7
	COOL	Dry	650	27.2	42.4
		Wet	585	29.6	42.0
MSZ-GX24NL MSY-GX24NL MSZ-GX30NL MSY-GX30NL MSZ-GX36NL MSY-GX36NL	HEAT (MSZ)	Dry	765	32.0	49.6
	COOL	Dry	765	32.0	49.6
		Wet	688	34.8	49.1

- The air coverage range is the figure up to the position where the air speed is 1 ft./sec., when air is blown out horizontally from the unit properly at the High speed position.

The coverage range should be used only as a general guideline since it varies according to the size of the room and furniture arranged inside the room.

5

OUTLINES AND DIMENSIONS

MSZ-GX06NL
MSY-GX09NL

MSZ-GX09NL
MSY-GX12NL

MSZ-GX12NL
MSY-GX15NL

MSZ-GX15NL

Unit: inch

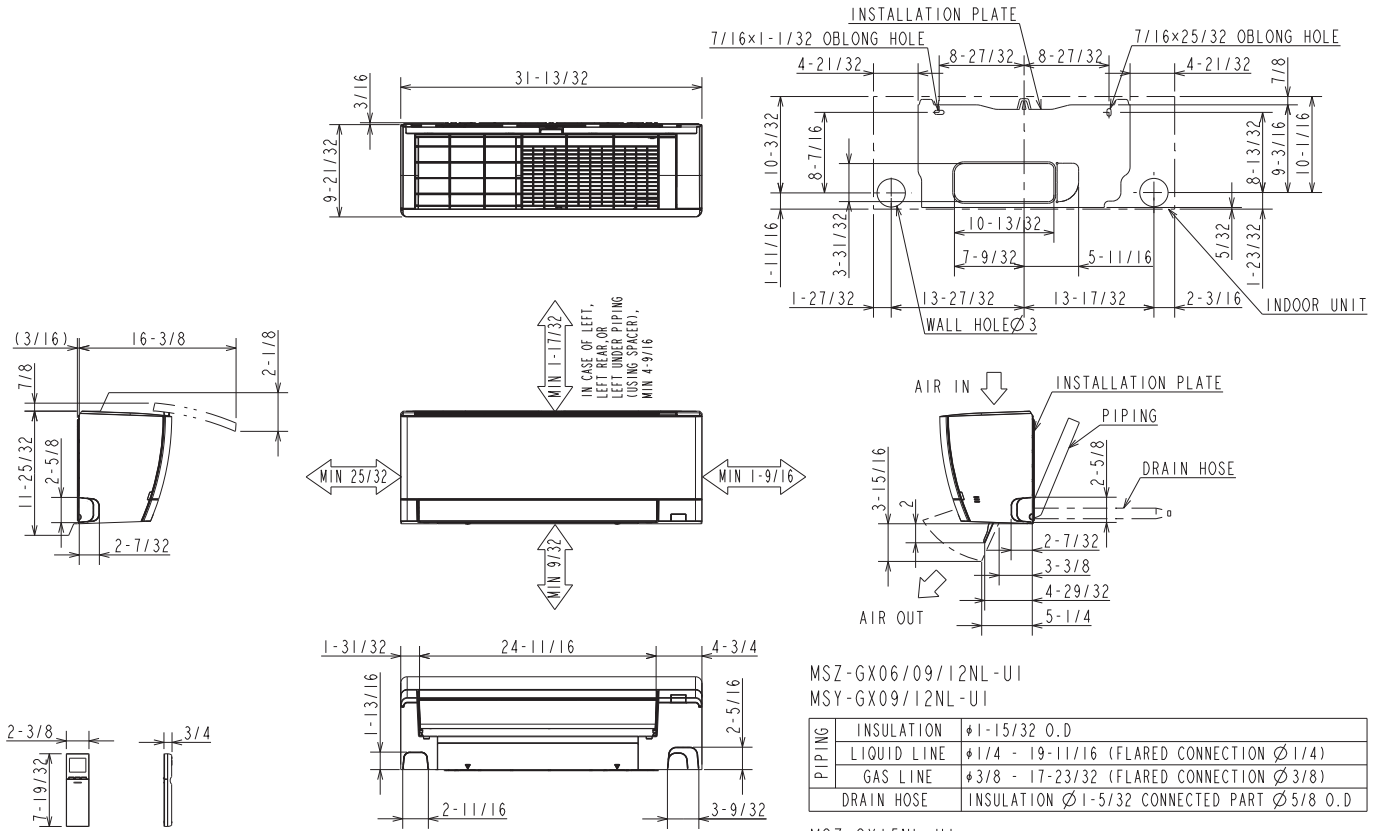

MSZ-GX06/09/12NL-U1
MSY-GX09/12NL-U1

PIPING	INSULATION	#1-15/32 O.D
	LIQUID LINE	#1/4 - 19-11/16 (FLARED CONNECTION Ø1/4)
	GAS LINE	#3/8 - 17-23/32 (FLARED CONNECTION Ø3/8)
	DRAIN HOSE	INSULATION Ø1-5/32 CONNECTED PART Ø5/8 O.D

MSZ-GX15NL-U1
MSY-GX15NL-U1

PIPING	INSULATION	#1-15/32 O.D
	LIQUID LINE	#1/4 - 19-11/16 (FLARED CONNECTION Ø1/4)
	GAS LINE	#3/8 - 17-23/32 (FLARED CONNECTION Ø1/2)
	DRAIN HOSE	INSULATION Ø1-5/32 CONNECTED PART Ø5/8 O.D

MSZ-GX18NL MSZ-GX24NL

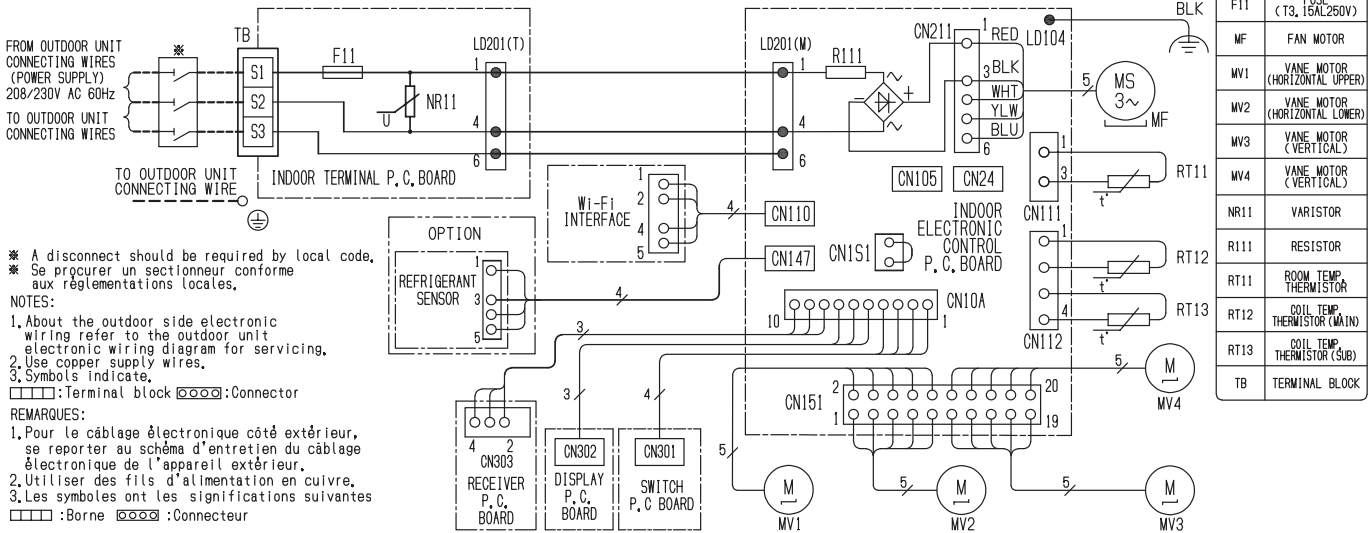

MSZ-GX30NL MSZ-GX36NL MSY-GX18NL MSY-GX24NL MSY-GX30NL MSY-GX36NL

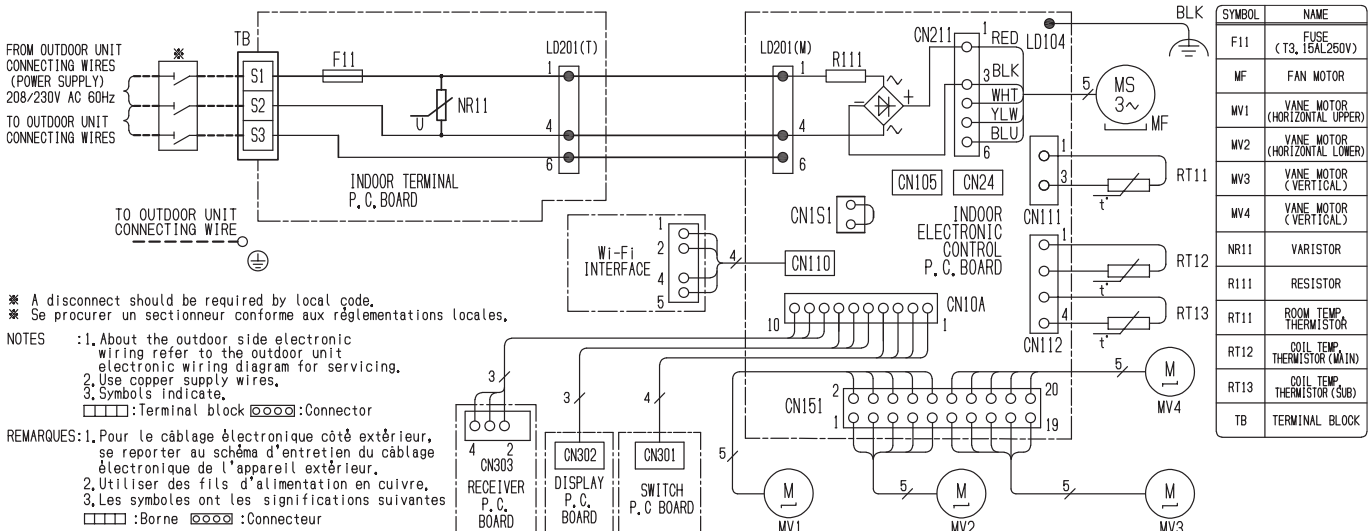

7

REFRIGERANT SYSTEM DIAGRAM

MSZ-GX06NL
MSY-GX09NL

MSZ-GX09NL
MSY-GX12NL

MSZ-GX12NL
MSY-GX15NL

MSZ-GX15NL

Unit: inch (mm)

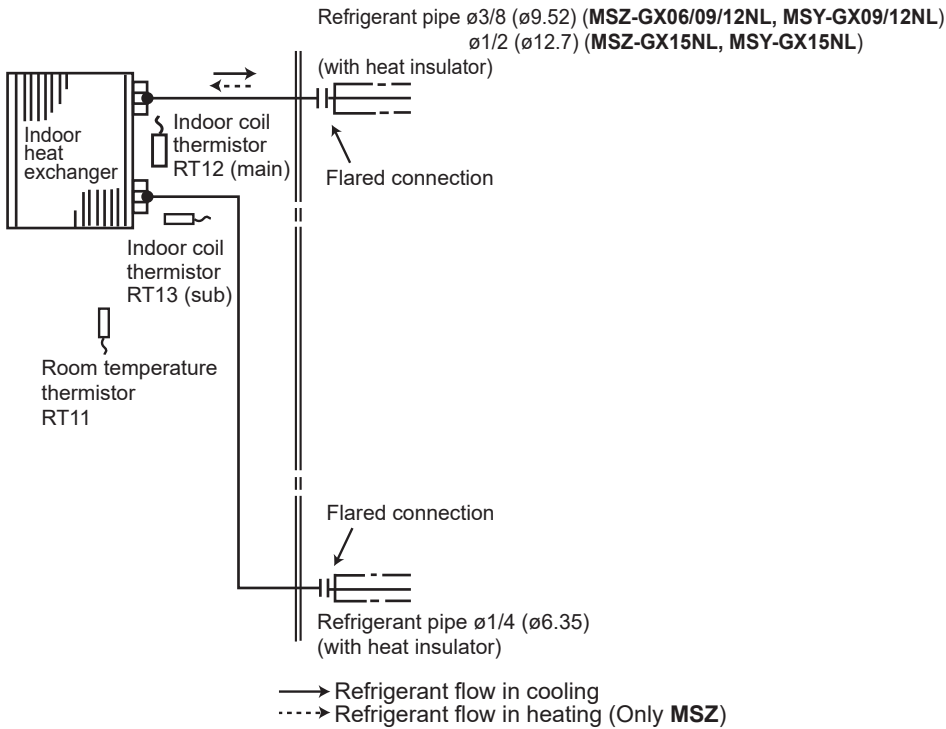

MSZ-GX18NL
MSY-GX18NL

MSZ-GX24NL
MSY-GX24NL

MSZ-GX30NL
MSY-GX30NL

MSZ-GX36NL
MSY-GX36NL

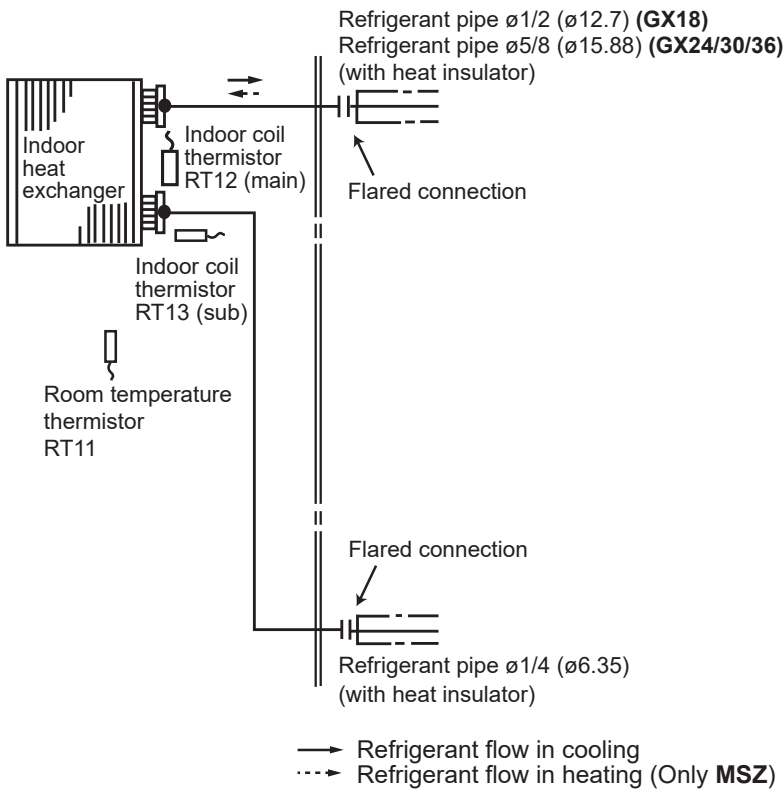

MSZ-GX06NL	MSZ-GX09NL	MSZ-GX12NL	MSZ-GX15NL	MSZ-GX18NL
MSZ-GX24NL	MSZ-GX30NL	MSZ-GX36NL		
MSY-GX09NL	MSY-GX12NL	MSY-GX15NL	MSY-GX18NL	MSY-GX24NL
MSY-GX30NL	MSY-GX36NL			

8-1. TIMER SHORT MODE

For service, the following set time can be shortened by bridging the timer short mode point on the electronic control P.C. board. The time will be shortened as follows. (Refer to 10-7.)

Set time : 1-minute → 1-second

Set time : 3-minute → 3-second (It takes 3 minutes for the compressor to start operation. However, the starting time is shortened by short circuit-of the timer short mode point.)

8-2.HOW TO SET REMOTE CONTROLLER EXCLUSIVELY FOR A PARTICULAR INDOOR UNIT

A maximum of 4 indoor units with wireless remote controllers can be used in a room.

To operate the indoor units individually with each remote controller, assign a number to each remote controller according to the number of the indoor unit.

This setting can be set only when all the following conditions are met:

- The remote controller is powered OFF.
- Weekly timer is not set.
- Weekly timer is not being edited.

(1) Hold down  button on the remote controller for 2 seconds to enter the pairing mode.

(2) Press  button again and assign a number to each remote controller.

Each press of  button advances the number in the following order: 1 → 2 → 3 → 4.

(3) Press  button to complete the pairing setting.

After you turn the breaker ON, the remote controller that first sends a signal to an indoor unit will be regarded as the remote controller for the indoor unit.

Once they are set, the indoor unit will only receive the signal from the assigned remote controller afterwards.

8-3. AUTO RESTART FUNCTION

When the indoor unit is controlled with the remote controller, the operation mode, the set temperature, and the fan speed are memorized by the indoor electronic control P.C. board. "AUTO RESTART FUNCTION" automatically starts operation in the same mode just before the shutoff of the main power.

Operation

- ① If the main power has been cut, the operation settings remain.
- ② After the power is restored, the unit restarts automatically according to the memory.
(However, it takes at least 3 minutes for the compressor to start running.)

How to disable "AUTO RESTART FUNCTION"

- ① Turn off the main power for the unit.
- ② Cut the jumper wire to JR77 on the indoor electronic control P.C. board. (Refer to 10-7.)

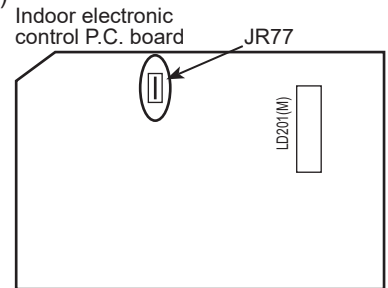

NOTE:



- The operation settings are memorized when 10 seconds have passed after the indoor unit was operated with the remote controller.
- If main power is turned OFF or a power failure occurs while AUTO START/STOP timer is active, the timer setting is cancelled.
- If the unit has been off with the remote controller before power failure, the auto restart function does not work as the power button of the remote controller is OFF.
- To prevent breaker OFF due to the rush of starting current, systematize other home appliance not to turn ON at the same time.
- When some air conditioners are connected to the same supply system, if they are operated before power failure, the starting current of all the compressors may flow simultaneously at restart.
Therefore, the special counter-measures are required to prevent the main voltage-drop or the rush of the starting current by adding to the system that allows the units to start one by one.

8-4. WIRELESS LAN CONTROL

1. Radio wave usage precautions

Contains FCC ID:NKR-MB43

Contains IC:4441A-MB43

 CAUTION	
	<ul style="list-style-type: none">Changes or modifications not expressly approved by the party responsible for compliance could void the user's authority to operate the equipment. This device must not be co-located or operating in conjunction with any other antenna or transmitter.This device complies with FCC/IC radiation exposure limits set forth for an uncontrolled environment and meets the FCC radio frequency (RF) Exposure Guidelines and RSS-102 of the IC radio frequency (RF) Exposure rules. This device should be installed and operated keeping the radiator at least 7-7/8 in. (20 cm) or more away from person's body.This device complies with part 15 of the FCC Rules and Industry Canada license-exempt RSSs. Operation is subject to the following two conditions: (1) This device may not cause harmful interference; and (2) This device must accept any interference received, including interference that may cause undesired operation. <p>NOTE: This device has been tested and found to comply with the limits for a Class B digital device, pursuant to part 15 of the FCC Rules. These limits are designed to provide reasonable protection against harmful interference in a residential installation. This equipment generates, uses and can radiate radio frequency energy and, if not installed and used in accordance with the instructions, may cause harmful interference to radio communications. However, there is no guarantee that interference will not occur in a particular installation. If this equipment does cause harmful interference to radio or television reception, which can be determined by turning the equipment off and on, the user is encouraged to try to correct the interference by one or more of the following measures:</p> <ul style="list-style-type: none">Reorient or relocate the receiving antenna.Increase the separation between the equipment and receiver.Connect the equipment into an outlet on a circuit different from that to which the receiver is connected.Consult the dealer or an experienced radio/TV technician for help.

2. Wireless LAN module introduction

This Wireless LAN module, communicates the status information and controls the commands from the kumo cloud® by connecting to an indoor unit.

3. Setting up

3-1. Download the kumo cloud® application

<https://www.mitsubishicomfort.com/kumocloud>



3-2. Create an account and log into it according to the owner manual of the kumo cloud®

Owner manual

https://docs.kumocloud.com/owner_manual.pdf



* Professional work is required to complete the setup of connecting the indoor unit to the kumo cloud®.

4. When it doesn't connect well

Check the following, and pair the Wireless LAN module and the Router.





- Make sure that the Wireless LAN module connect to a 2.4 GHz Wi-Fi network. The Wireless LAN module will not work on 5 GHz Wi-Fi network.
- Make sure that the communication distance is not too far between the Wireless LAN module and the Router.
- Make sure that the number of connected devices to the Router does not exceed the limit.
- Check if the Router is connected to Internet.
- Set up the Wireless LAN module after operating the air conditioner using the wireless remote controller at least once.

4-1. Reconnect the Wireless Network

At the first install, the system will automatically start into network configuration mode. After the system has been configured to connect to a wireless network, in order to change the settings to a different network, the user can follow the instructions below to place the system back into network configuration mode.

Reconnect the wireless network after a new wireless router has been installed and connected to the internet or reconnect the wireless network if kumo cloud® was set up in a new construction with a temporary network.

Sending “3” with the remote controller switches the connection mode.

- Press  to stop the operation.
- Hold down the Temperature  for 5 seconds.
- Select “3” by pressing Temperature  and .
- Point the remote controller toward the indoor unit and press the .

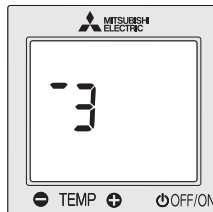

You can check the connection mode by the blinking state of the Connection mode LED (green light).

- * The blinking state of the LED can change due to an update. Refer to the latest operation manual of the kumo cloud®.





NOTE:

The connection modes and the lighting/blinking state of each mode can change due to an update. Refer to the latest operation manual of the kumo cloud®.

5. Checking the wireless setting status

You can check the transmission conditions with operation indicator lamp on indoor unit. Follow the procedure below when you cannot connect the wireless LAN module to the wireless network or transmission error occurs.

5-1. Wireless status display mode

- Press  to stop the operation.
- Hold down the Temperature  for 5 seconds.
- Select “9” by pressing Temperature  and .
- Point the remote controller toward the indoor unit and press the .

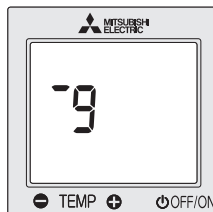

- Refer to the operation manual of the kumo cloud® for operation indicator lamp on indoor unit and wireless LAN module.

NOTE:

- When operating the air conditioner from a position where you cannot see it, check the air conditioner, its surroundings, and the conditions of people in the room in advance.
- When there are people in the room, let them know in advance that you will be operating the air conditioner from a distance.
- Ensure that the Router supports the WPA2-AES encryption setting before starting the Wireless LAN module setup.
- The End user should read and accept the terms and conditions of the kumo cloud® service before using this Wireless LAN module.
- Use of the Wireless LAN module implies acceptance of our terms and conditions.
- To complete connection to the kumo cloud® physical access to the access point may be required.
- This Wireless LAN module will not commence transmission of any operational data from the system until the End user registers and accepts the terms and conditions of the Wi-Fi service.
- This Wireless LAN module should not be connected to any Mitsubishi Electric system which is to provide cooling or heating to critical applications.
- Mitsubishi Electric's Wireless LAN module is designed for communication to Mitsubishi Electric's kumo cloud®. Mitsubishi Electric is not responsible for any (i) underperformance of a system or any product; (ii) system or product fault; or (iii) loss or damage to any system or product; which is caused by or arises from connection to and/or use of any third party Wireless LAN module or any third party wireless or Wi-Fi service with Mitsubishi Electric equipment

The Wireless LAN module uses Open Source Software. To view the Open Source software licence(s), refer to the Licenses. https://docs.kumocloud.com/software_licenses.pdf

“Wi-Fi”, “WPA2.” are trademarks or registered trademarks of the Wi-Fi Alliance.

6. Specifications

Wireless LAN module specifications

Wireless LAN-compatible standard	IEEE802.11b/g/n
RF channel	1ch~11ch
Frequency Band	2.4GHz only
Security	WPA2 only
FCC ID	NKR-MB43
IC	4441A-MB43

MICROPROCESSOR CONTROL

- | | | | | |
|------------|------------|------------|------------|------------|
| MSZ-GX06NL | MSZ-GX09NL | MSZ-GX12NL | MSZ-GX15NL | MSZ-GX18NL |
| MSZ-GX24NL | MSZ-GX30NL | MSZ-GX36NL | | |
| MSY-GX09NL | MSY-GX12NL | MSY-GX15NL | MSY-GX18NL | MSY-GX24NL |
| MSY-GX30NL | MSY-GX36NL | | | |

WIRELESS REMOTE CONTROLLER

These pictures show MSZ type.

- | | | | |
|------------|------------|------------|------------|
| MSZ-GX06NL | MSZ-GX09NL | MSZ-GX12NL | MSZ-GX15NL |
| MSY-GX09NL | MSY-GX12NL | MSY-GX15NL | |

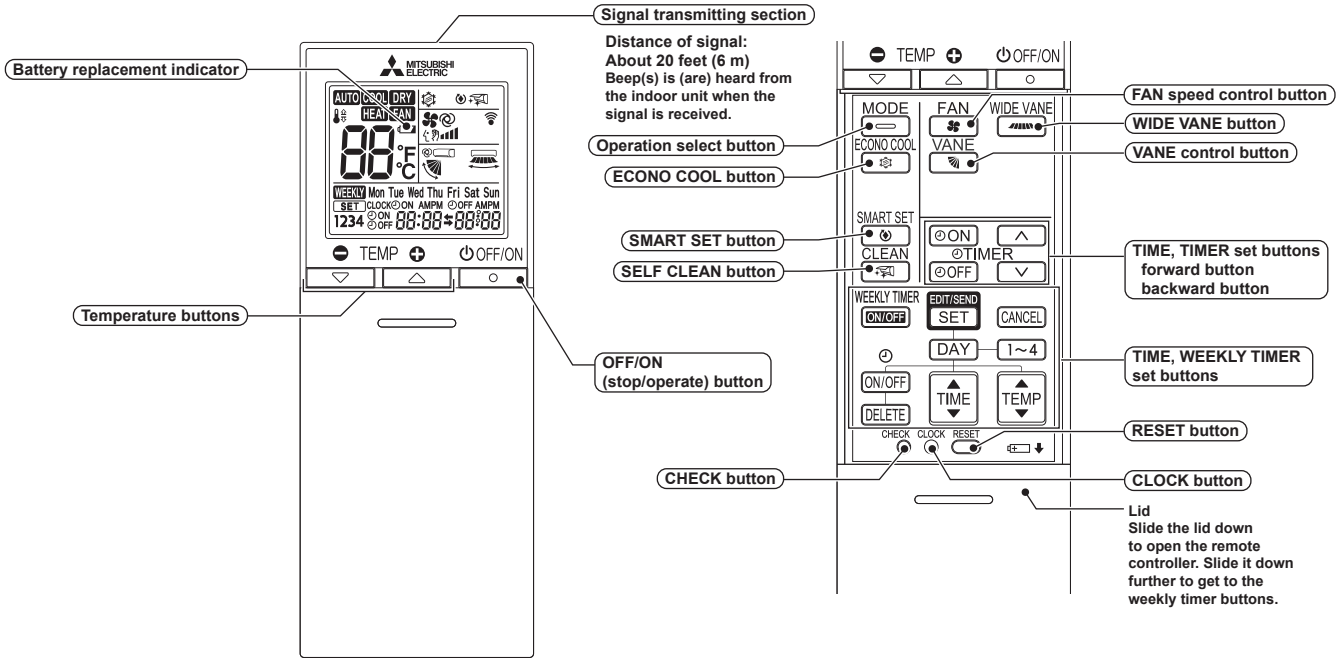

- | | | | |
|------------|------------|------------|------------|
| MSZ-GX18NL | MSZ-GX24NL | MSZ-GX30NL | MSZ-GX36NL |
| MSY-GX18NL | MSY-GX24NL | MSY-GX30NL | MSY-GX36NL |

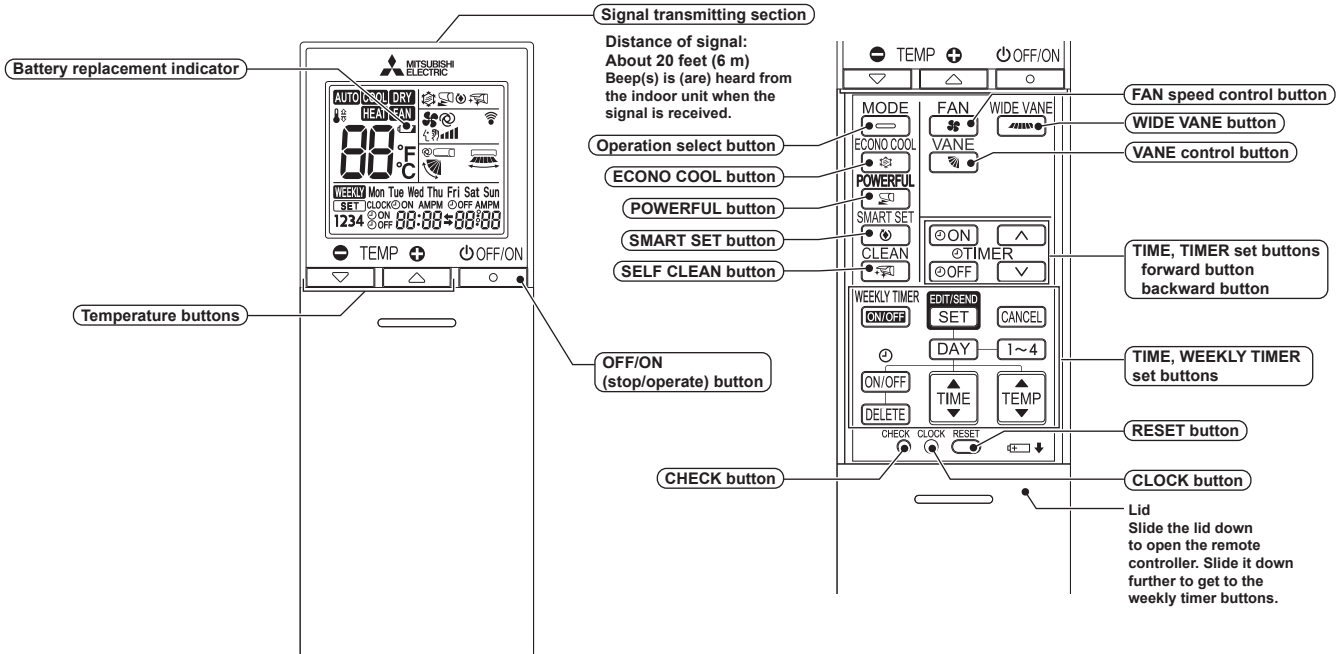

* The backlight turns on when using the remote controller.
The backlight goes off if the remote controller is not used for a while.



NOTE: Last setting will be stored after the unit is turned OFF with the remote controller. Indoor unit receives the signal of the remote controller with beeps.

INDOOR UNIT DISPLAY SECTION

Operation indicator lamp



The operation indicator at the right side of the indoor unit indicates the operation state.

- The following indication applies regardless of shape of the indication.

Indication	Operation state	Room temperature
	The unit is operating to reach the set temperature	About 4°F(2°C) or more away from set temperature
	The room temperature is approaching the set temperature	About 2 to 4°F(1 to 2°C) from set temperature
	Standby mode (Only during multi system operation) (MSZ-GX06/09/12/15/18/24)	—

-  Lit
-  Blinking
-  Not lit

9-1. COOL (**COOL**) OPERATION

- Press OFF/ON (stop/operate) button.
Operation indicator lamp of the indoor unit turns on with a beep tone.
- Select COOL mode with Operation select button.
- Press Temperature buttons (TEMP  or  button) to select the desired temperature. The setting range is 61 – 88°F (16 – 31°C)

1. Coil frost prevention

When the temperature of indoor heat exchanger becomes too low, the coil frost prevention mode works.

The indoor fan operates at the set speed and the compressor stops. This mode continues until the temperature of indoor heat exchanger rises.

2. Low outside temperature operation

When the outside temperature is lower, low outside temperature operation starts, and the outdoor fan slows or stops.

9-2. DRY (**DRY**) OPERATION

- Press OFF/ON (stop/operate) button.
Operation indicator lamp of the indoor unit turns on with a beep tone.
- Select DRY mode with Operation select button.
- The set temperature is determined from the initial room temperature.



1. Coil frost prevention

Coil frost prevention is as same as COOL mode. (9-1.1.)

2. Low outside temperature operation

Low outside temperature operation is as same as COOL mode. (9-1.2.)

9-3. HEAT (**HEAT**) OPERATION (MSZ)

- Press OFF/ON (stop/operate) button.
Operation indicator lamp of the indoor unit turns on with a beep tone.
- Select HEAT mode with Operation select button.
- Press Temperature buttons (TEMP  or  button) to select the desired temperature.
The setting range is 50 – 88°F (10 – 31°C).

1. Cold air prevention control

When the compressor is not operating or is starting, and the temperature of indoor heat exchanger and/or the room temperature is low or when defrosting is being done, the indoor fan will stop or rotate in Very Low speed.

2. High pressure protection

The compressor operational frequency is controlled by the temperature of the indoor heat exchanger to prevent the condensing pressure from increasing excessively.

When the temperature of indoor heat exchanger becomes too high, the high pressure protection works.

The indoor fan operates following the cold air prevention control. This mode continues until the temperature of indoor heat exchanger falls.

3. Defrosting

Defrosting starts when the temperature of outdoor heat exchanger becomes too low.

The compressor stops once, the indoor/outdoor fans stop, the 4-way valve reverses and the compressor re-starts.

This mode continues until the temperature of outdoor heat exchanger rises or the fixed time passes.

9-4. FAN (**FAN**) OPERATION

- (1) Press OFF/ON (stop/operate) button.
Operation indicator lamp of the indoor unit turns ON with a beep tone.
- (2) Select FAN mode with Operation select button.
- (3) Select the desired fan speed. When AUTO, it becomes Low.
Only indoor fan operates. Outdoor unit does not operate.

9-5. "I FEEL CONTROL" (**AUTO**) OPERATION (MSY)

- (1) Press OFF/ON (stop/operate) button on the remote controller.
Operation indicator lamp of the indoor unit turns on with a beep tone.
- (2) Select "I FEEL CONTROL" mode with Operation select button.
- (3) The operation mode is determined by the room temperature at start-up of the operation.
 - Once the mode is fixed, the mode does not change by room temperature afterwards.
 - Under the ON TIMER (⊙ON) operation, mode is determined according to the room temperature at the set time the operation starts.
- (4) The initial set temperature is decided by the initial room temperature.

Initial room temperature	Mode
77°F (25°C) or more	COOL mode of "I FEEL CONTROL"
More than 55°F (13°C), less than 77°F (25°C)	DRY mode of "I FEEL CONTROL"

Model	Initial room temperature	Initial set temperature	
COOL mode of "I FEEL CONTROL"	79°F (26°C) or more	75°F (24°C)	*1
	77°F (25°C) to 79°F (26°C)	Initial room temperature minus 4°F (2°C)	
DRY mode of "I FEEL CONTROL"	More than 55°F (13°C), less than 77°F (25°C)	Initial room temperature minus 4°F (2°C)	

*1 When the system is restarted with the remote controller, the system operates with the previous set temperature regardless of room temperature at restart.

The set temperature is calculated by the previous set temperature.

(5) Temperature buttons

In "I FEEL CONTROL" (**AUTO**) mode, set temperature is decided by the microprocessor based on the room temperature. In addition, set temperature can be controlled by Temperature buttons (TEMP ⊖ or ⊕ button) when you feel too cool or too warm.

Each time the temperature button (TEMP ⊖ or ⊕ button) is pressed, the indoor unit receives the signal and emits a beep tone.

• Fuzzy control

When the temperature button (TEMP ⊖ or ⊕ button) is pressed, the microprocessor changes the set temperature, considering the room temperature, the frequency of pressing Temperature buttons (TEMP ⊖ or ⊕ button) and the user's preference to heat or cool. So this is called "Fuzzy control", and works only in "I FEEL CONTROL" mode.

In DRY mode of "I FEEL CONTROL", the set temperature doesn't change.

TEMP ⊕... To raise the set temperature 2 – 4°F (1 – 2°C) TEMP ⊖... To lower the set temperature 2 – 4°F (1 – 2°C)

9-6. AUTO CHANGE OVER ... AUTO MODE OPERATION (MSZ)

Once desired temperature is set, unit operation is switched automatically between COOL and HEAT operation.

Mode selection

(1) Initial mode

When unit starts the operation with AUTO operation from off;

- If the room temperature is higher than the set temperature, operation starts in COOL mode.
- If the room temperature is equal to or lower than the set temperature, operation starts in HEAT mode.

(2) Mode change

COOL mode changes to HEAT mode when about 15 minutes have passed with the room temperature 4°F (2°C) below the set temperature.

HEAT mode changes to COOL mode when about 15 minutes have passed with the room temperature 4°F (2°C) above the set temperature.

NOTE 1

If 2 or more indoor units are operating in multi system, there might be a case that the indoor unit, which is operating in **AUTO** (AUTO), cannot change over to the other operating mode (COOL ↔ HEAT) and becomes a state of standby.

Refer to **NOTE 2 "FOR MULTI SYSTEM AIR CONDITIONER"**.

NOTE 2

FOR MULTI SYSTEM AIR CONDITIONER (MSZ-GX06/09/12/15/18/24)

OUTDOOR UNIT: MXZ series

Multi system air conditioner can connect 2 or more indoor units with 1 outdoor unit.

- When you try to operate 2 or more indoor units with 1 outdoor unit simultaneously, 1 for the cooling and the others for heating, the operation mode of the indoor unit that operates first is selected. Other indoor units cannot operate, and operation indicator lamp blinks as shown in the figure below. In this case, please set all the indoor units to the same operation mode.

<Operation indicator lamp>

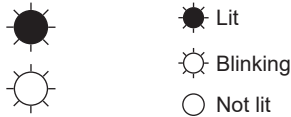

- When indoor unit starts the operation while the defrosting of outdoor unit is being done, it takes a few minutes (max. 10 minutes) to blow out the warm air.
- In the heating operation, though indoor unit that does not operate may get warm or the sound of refrigerant flowing may be heard, they are not malfunction. The reason is that the refrigerant continuously flows into it.

9-7. AUTO VANE OPERATION

1. Horizontal vane

(1) Vane motor drive

These models are equipped with a stepping motor for the horizontal vane. The rotating direction, speed, and angle of the motor are controlled by pulse signals (approximately 12 V) transmitted from indoor microprocessor.

(2) The horizontal vane angle and mode change as follows by pressing VANE control button.

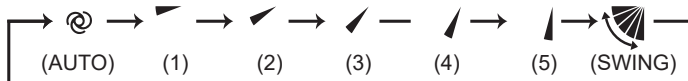

(3) Positioning

To confirm the standard position, the vane moves until it touches the vane stopper. Then the vane is set to the selected angle.

- The operation starts or finishes (including timer operation).
- The test run starts.
- When standby mode (only during multi system operation) starts or finishes.

(4) VANE AUTO (@) mode

The microprocessor automatically determines the horizontal vane angle and operation to make the optimum room temperature distribution.

In COOL, DRY and FAN operation
Vane angle is fixed to Horizontal position.



In HEAT operation (MSZ)
Vane angle is fixed to Angle 4.

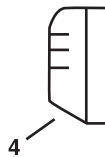

(5) STOP (operation OFF) and ON TIMER standby

In the following cases, the horizontal vane returns to the closed position.

- OFF/ON (stop/operate) button is pressed (POWER OFF).
- The operation is stopped by the emergency operation.
- ON TIMER is ON standby.

(6) Dew prevention

During COOL or DRY operation with the vane angle at Angle 5 (GX06/09/12/15) / Angle 4 – 5 (GX18/24/30/36) when the compressor cumulative operation time exceeds 1 hour, the vane angle automatically changes to Angle 4 (GX06/09/12/15) / Angle 3 (GX18/24/30/36) for dew prevention.

(7) SWING () mode

By selecting SWING mode with VANE control button, the horizontal vane swings vertically.

(8) Cold air prevention in HEAT operation (MSZ)

The horizontal vane position is set to Upward.

NOTE: When 2 or more indoor units are operated with multi outdoor unit, even if any indoor unit turns thermostat OFF, this control does not work in the indoor unit.

(9) **ECONO COOL** (🌀) operation (ECONOMical operation)

When ECONO COOL button is pressed in COOL mode, set temperature is automatically set 4°F (2°C) higher by the microprocessor. However, the temperature on the LCD screen on the remote controller is not changed. Also the horizontal vane swings in various cycle.

SWING operation makes you feel cooler than set temperature. So, even though the set temperature is higher, the air conditioner can keep comfort. As a result, energy can be saved.

To cancel this operation, select a different mode or press one of the following buttons in ECONO COOL operation: ECONO COOL, VANE control or POWERFUL button.

(10) **POWERFUL** (🌀) operation (**MSZ-GX18/24/30/36NL, MSY-GX18/24/30/36NL**)

The air conditioner automatically adjusts the fan speed and the set temperature, and operates the POWERFUL mode.

The POWERFUL mode is cancelled automatically 15 minutes after operation starts, or when POWERFUL button is pressed once again within 15 minutes after operation starts. The operation mode returns to the mode prior to POWERFUL operation. To manually cancel this operation, select a different mode or press one of the following buttons: FAN speed.

2. Vertical vane

(1) Vane motor drive

These models are equipped with a stepping motor for the vertical vane. The rotating direction, speed, and angle of the motor are controlled by pulse signals (approximately 12 V) transmitted from microprocessor.

(2) Press WIDE VANE button to select horizontal airflow direction. Each press changes airflow direction in the following order:

GX06/09/12/15

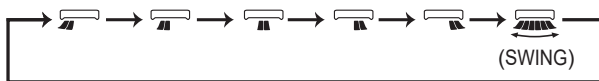

GX18/24/30/36

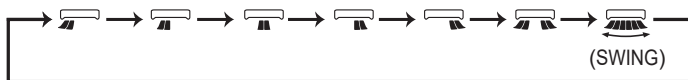

(3) Positioning

To confirm the standard position, the vane moves until it touches the vane stopper.

Then the vane is set to the desired angle.

Confirming of standard position is performed.

(a) OFF/ON (stop/operate) button is pressed (POWER ON/OFF).

(b) SWING is started or finished.

(c) The power supply turns ON.

(4) **SWING MODE** (🌀)

By selecting SWING mode with WIDE VANE button, the vertical vane swings horizontally.

The remote controller displays "🌀".

(5) **WIDE MODE** (🌀) (**GX18/24/30/36**)

By selecting WIDE mode with WIDE VANE button, indoor fan speed becomes faster than setting fan speed on the remote controller (*). The remote controller displays "🌀".

NOTE : The position of vane angle 3, angle 4 and angle 5 are different in COOL operation and HEAT operation.

* Indoor fan speed becomes faster than setting fan speed on the remote controller even when 🌀 or 🌀 is selected.

9-8. TIMER OPERATION

1. How to set the time

(1) Check that the current time is set correctly.

NOTE: Timer operation will not work without setting the current time. Initially "12:00 AM" blinks at the current time display of TIME MONITOR, so set the current time correctly with CLOCK button.

How to set the current time

(a) Press the CLOCK button.

(b) Press the TIME SET buttons (\uparrow and \downarrow) to set the current time.

- Each time forward button (\uparrow) is pressed, the set time increases by 1 minute, and each time backward button (\downarrow) is pressed, the set time decreases by 1 minute.

- Pressing those buttons longer, the set time increases/decreases by 10 minutes.

(c) Press the CLOCK set button.

(2) Press OFF/ON (stop/operate) button to start the air conditioner.

(3) Set the time of timer.

ON timer setting

(a) Press ON TIMER button (ON) during operation.

(b) Set the time of the timer using TIME SET buttons (\uparrow and \downarrow). *

OFF timer setting

(a) Press OFF TIMER button (OFF) during operation.

(b) Set the time of the timer using TIME SET buttons (\uparrow and \downarrow). *

* Each time forward button (\uparrow) is pressed, the set time increases by 10 minutes: each time backward button (\downarrow) is pressed, the set time decreases by 10 minutes.

2. To release the timer

To release ON timer, press ON TIMER button (ON).

To release OFF timer, press OFF TIMER button (OFF).

TIMER is cancelled and the display of set time disappears.

PROGRAM TIMER

- OFF timer and ON timer can be used in combination. The set time that is reached first will operate first.
- "➡" and "⬅" display shows the order of OFF timer and ON timer operation.

(Example 1) The current time is 8:00 PM.

The unit turns off at 11:00 PM, and on at 6:00 AM.

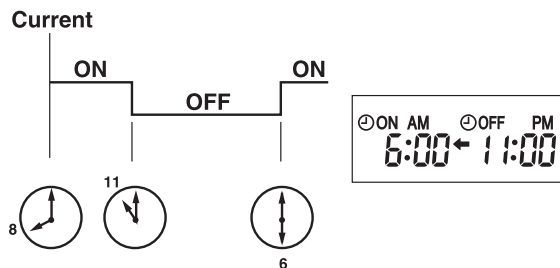

(Example 2) The current time is 11:00 AM.

The unit turns on at 5:00 PM, and off at 9:00 PM.

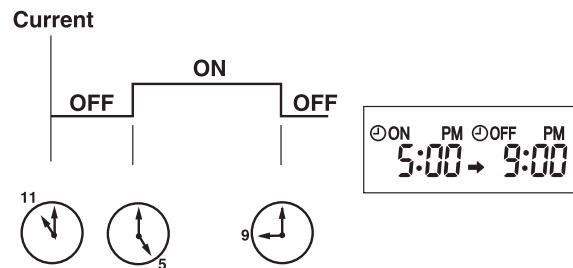

NOTE: If the main power is turned OFF or a power failure occurs while ON/OFF timer is active, the timer setting is cancelled. As these models are equipped with an auto restart function, the air conditioner starts operating with timer cancelled when power is restored.

9-9. WEEKLY TIMER OPERATION

- A maximum of 4 ON or OFF timers can be set for individual days of the week.
- A maximum of 28 ON or OFF timers can be set for a week.

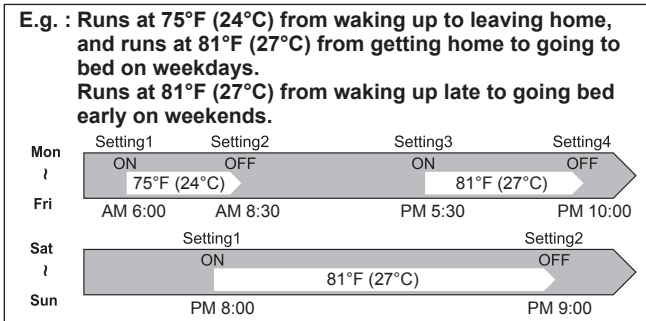

NOTE:

- The simple ON/OFF timer setting is available while the weekly timer is on. In this case, the ON/OFF timer has priority over the weekly timer; the weekly timer operation will start again after the simple ON/OFF timer is complete.
- When the weekly timer is set, temperature can not be set to 50°F (10°C).
- The weekly timer operation and SMART SET operation cannot be used together.

1. How to set the weekly timer

* Make sure that the current time and day are set correctly.

- (1) Press **EDIT/SEND** button to enter the weekly timer setting mode.

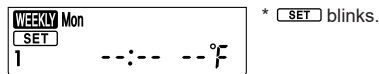

- (2) Press **DAY** and **1~4** buttons to select setting day and number.

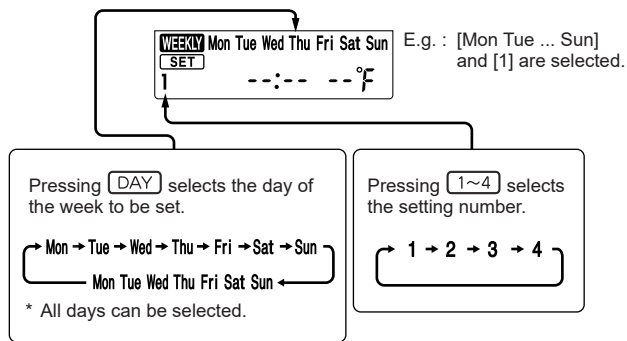

- (3) Press **ON/OFF**, **TIME**, and **TEMP** buttons to set ON/OFF, time, and temperature.

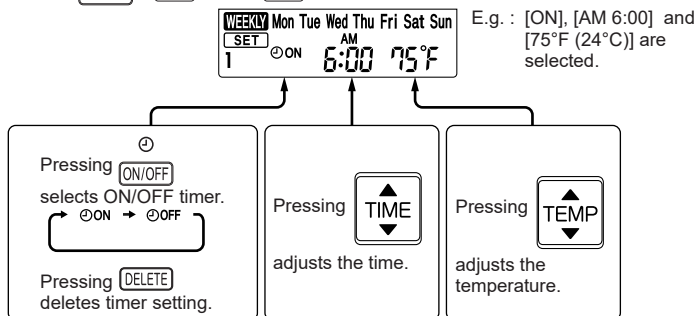



* Hold down the button to change the time quickly.

* The temperature can be set between 61°F and 88°F (16°C and 31°C) at weekly timer.



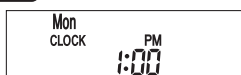

Press **DAY** and **1~4** buttons to continue setting the timer for other days and/or numbers.



(4) Press  button to complete and transmit the weekly timer setting.





*  which was blinking goes out, and the current time will be displayed.

NOTE:

- Press  button to transmit the setting information of weekly timer to the indoor unit. Point the remote controller toward the indoor unit for 3 seconds.
- When setting the timer for more than one day of the week or one number,  button does not have to be pressed per each setting. Press  button once after all the settings are complete. All the weekly timer settings will be saved.
- Press  button to enter the weekly timer setting mode, and press and hold  button for 5 seconds to erase all weekly timer settings. Point the remote controller toward the indoor unit.

(5) Press  button to turn the weekly timer ON. (.)

- When the weekly timer is ON, the day of the week whose timer setting is complete, will light.

Press  button again to turn the weekly timer OFF. (.)

NOTE:

The saved settings will not be cleared when the weekly timer is turned OFF.

2. Checking weekly timer setting

(1) Press  button to enter the weekly timer setting mode.

* blinks.

(2) Press  or  buttons to view the setting of the particular day or number.

(3) Press  button to exit the weekly timer setting.

NOTE:

When all days of the week are selected to view the settings and a different setting is included among them,  will be displayed.

9-10. SMART SET (☺) OPERATION

1. How to set SMART SET operation

- (1) Press OFF/ON (stop/operate) button.
- (2) Select COOL or HEAT (**MSZ**) mode.
- (3) Press SMART SET button.
- (4) Set the temperature, fan speed, and airflow direction for SMART SET operation.

NOTE: • SMART SET operation cannot be selected during DRY or AUTO mode operation.

- The setting range of HEAT mode in SMART SET operation is between 50 – 88°F (10 – 31°C).
- 2 settings can be saved. (One for COOL, one for HEAT) (**MSZ**).
- 1 setting can be saved. (**MSY**).

2. How to cancel operation

- Press SMART SET button again.
- SMART SET operation can also be cancelled by pressing Operation select button to change the operation mode. The same setting will be selected from the next time by simply pressing SMART SET button.

9-11. SELF CLEAN OPERATION

SELF CLEAN operation helps to keep the unit clean by performing FAN operation for about 25 minutes. It is recommended to keep SELF CLEAN operation active at all times.

(1) Press SELF CLEAN button to activate SELF CLEAN operation.

- The unit performs SELF CLEAN operation when it is stopped with the OFF/ON (stop/operate) button or OFF timer after COOL/DRY operation. Operation indicator lamp turns on. (Display section)
- SELF CLEAN operation is not performed when: COOL/DRY is operated less than 3 minutes.

(2) Press SELF CLEAN button again to deactivate SELF CLEAN operation.

- Pressing OFF/ON (stop/operate) button does not deactivate SELF CLEAN operation.

NOTE:

- Fan is stopped for the first 3 minutes of SELF CLEAN operation.
- During multi system operation, air from the unit may become warm. In this case, SELF CLEAN operation is cancelled automatically to prevent undesirable rise in room temperature.

9-12. EMERGENCY/TEST OPERATION

In case of test run operation or emergency operation, use the emergency operation switch on the front of the indoor unit. Emergency operation is available when the remote controller is missing, has failed or the batteries of the remote controller run down. The unit will start and operation indicator lamp will light.

The first 30 minutes of operation is the test run operation. This operation is for servicing. The Indoor fan speed runs at High speed and the temperature control does not work.

After 30 minutes of test run operation the system shifts to EMERGENCY COOL/HEAT(**MSZ**) MODE with a set temperature of 75°F (24°C). The fan speed shifts to Med.

The coil frost prevention works even in the test run or the emergency operation.

In the test run or emergency operation, the horizontal vane operates in VANE AUTO (Ⓢ) mode.

Emergency operation continues until the emergency operation switch is pressed once or twice or the unit receives any signal from the remote controller. In case of latter normal operation will start.

NOTE : Do not press the emergency operation switch during normal operation.

MSZ-GX06/09/12/15NL

MSY-GX09/12/15NL

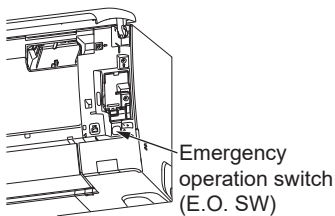

Operation mode	COOL	HEAT (MSZ)
Set temperature	75°F(24°C)	75°F(24°C)
Fan speed	Med.	Med.
Horizontal vane	Auto	Auto

The operation mode is indicated by the operation indicator lamp as follows.

Operation indicator lamp

MSZ

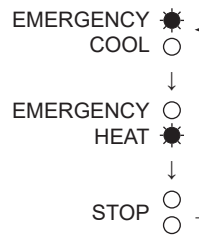

MSY

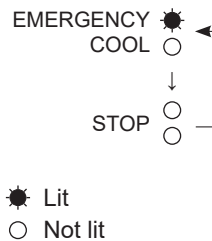

MSZ-GX18/24/30/36NL
MSY-GX18/24/30/36NL

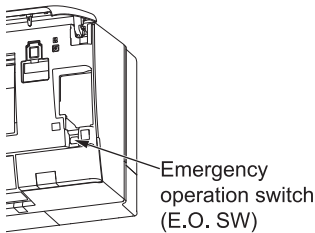

9-13. 3-MINUTE TIME DELAY OPERATION

When the system turns OFF, compressor will not restart for 3 minutes as 3-minute time delay function operates to protect compressor from overload.

9-14. CHANGING TEMPERATURE INDICATION (°F/°C)

- The preset unit is °F.
- °F→°C/°C→°F: Press RESET button while the temperature buttons are pressed.

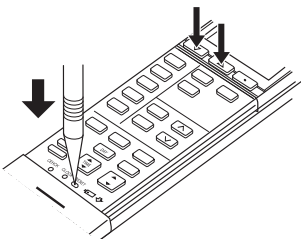

Press RESET button gently using a fine-tipped object.

MSZ-GX06NL
MSZ-GX24NL
MSY-GX09NL
MSY-GX30NL

MSZ-GX09NL
MSZ-GX30NL
MSY-GX12NL
MSY-GX36NL

MSZ-GX12NL
MSZ-GX36NL
MSY-GX15NL

MSZ-GX15NL
MSY-GX18NL

MSZ-GX18NL
MSY-GX24NL

10-1. CAUTIONS ON TROUBLESHOOTING

1. Before troubleshooting, check the following

- 1) Check the power supply voltage.
- 2) Check the indoor/outdoor connecting wire for miswiring.

2. Take care of the following during servicing

- 1) Before servicing the air conditioner, be sure to turn off the unit first with the remote controller, and then after confirming the horizontal vane is closed, turn off the breaker and/or disconnect the power plug.
- 2) Be sure to turn OFF the power supply before removing the front panel, the cabinet, the top panel, and the electronic control P.C. board.
- 3) When removing the electronic control P.C. board, hold the edge of the board with care NOT to apply stress on the components.
- 4) When connecting or disconnecting the connectors, hold the housing of the connector. DO NOT pull the lead wires.

<Incorrect>



Lead wiring

<Correct>



Housing point

3. Troubleshooting procedure

- 1) First, check if the operation indicator lamp on the indoor unit is blinking on and off to indicate an abnormality. To make sure, check how many times the operation indicator lamp is blinking on and off before starting service work.
- 2) Before servicing, verify that all connectors and terminals are connected properly.
- 3) When the electronic control P.C. board seems to be defective, check for disconnection of the copper foil pattern and burnt or discolored components.
- 4) When troubleshooting, refer to 10-2, 10-3. and 10-4.

4. How to replace batteries

Weak batteries may cause the remote controller malfunction.

In this case, replace the batteries to operate the remote controller normally.

- ① Remove the front lid and insert batteries. Then reattach the front lid.

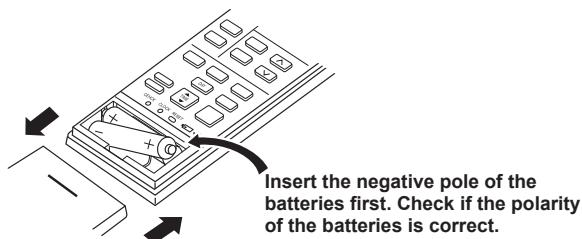

- ② Press RESET button with a fine-tipped object, and then use the remote controller.

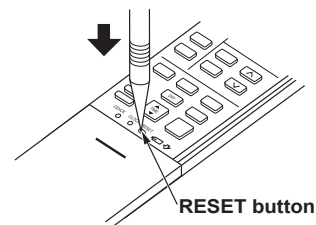

NOTE : 1. If RESET button is not pressed, the remote controller may not operate correctly.

2. This remote controller has a circuit to automatically reset the microprocessor when batteries are replaced. This function is equipped to prevent the microprocessor from malfunctioning due to the voltage drop caused by the battery replacement.
3. Do not use the leaking batteries.

10-2. FAILURE MODE RECALL FUNCTION AND ERROR CODE DISPLAY MODE

Outline of the function

This air conditioner can memorize the failure which has occurred last time.

Even though LED indication listed on the troubleshooting check table (10-4.) disappears, the memorized failure can be recalled.

Also, error code can be checked on the display of remote controller while the upper operation indicator lamp on the indoor unit is blinking.

1. Flow chart of failure mode recall function for the indoor/outdoor unit

Operational procedure

The cause of abnormality cannot be identified because the error code does not appear again.

Setting up the failure mode recall function (Figure 1)

Turn ON the power supply.
 <Preparation of the remote controller>
 ① While pressing Operation select button and TEMP \oplus button on the remote controller at the same time, press RESET button.
 ② First, release RESET button.
 Hold down the other 2 buttons for another 3 seconds. Make sure that the indicators on the LCD display shown in Figure 1 have all appeared. ("00" is shown in the display.) Then release the buttons.

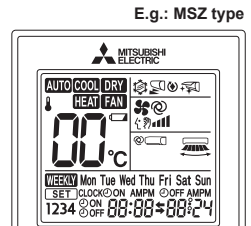
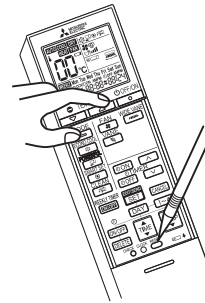

E.g.: MSZ type

An example of error code (00)

Figure 1

Check of operation indicator lamp

Check of error code on the display of remote controller

Get close to the front of the indoor unit. Press OFF/ON (stop/operate) button of the remote controller with the remote controller headed towards the indoor unit.

Did the indoor unit beep?

No

1st

2nd

Yes *1

Get closer to the indoor unit, then try again.

Turn off the power of appliances such as fluorescent lamp and TV which might cause noise, then try again. (If the battery replacement indicator lights up, replace the batteries with new ones.)

How many beeps?

2 times

1 time

The indoor unit is normal, but the outdoor unit might be abnormal. There are some abnormalities that cannot be recalled with this way. Check if the outdoor unit is abnormal according to the outdoor unit failure mode recall function. (Refer to the outdoor unit service manual.)

The unit has an error.

Press TEMP \oplus or \ominus to change an error code. Each press of TEMP \oplus changes the error code shown on the remote controller in ascending order (A to Z). (Figure 2) Each press of TEMP \ominus changes the error code in descending order (Z to A). Check the error code one by one to send the signal.

How many beeps?

No beeps

2 times

1 time

The diagnosis has failed. Try again.

The unit does not have the error corresponding to the error code shown on the remote controller. Continue checking.

The unit has the error corresponding to the error code.

Judgment of indoor/outdoor abnormality

Is the error code in the table of indoor unit failure mode recall function? (10-2.3.)

No

Yes

The outdoor unit is abnormal. Check the error code, and identify the abnormal point by referring to the table of outdoor unit failure mode recall function. (Refer to the outdoor unit service manual.)

The indoor unit is abnormal. Check the error code, and identify the abnormal point by referring to the table of indoor unit failure mode recall function. (10-2.3.)

B (To next page)

A (To next page)

00 → E6 → → UP

Figure 2

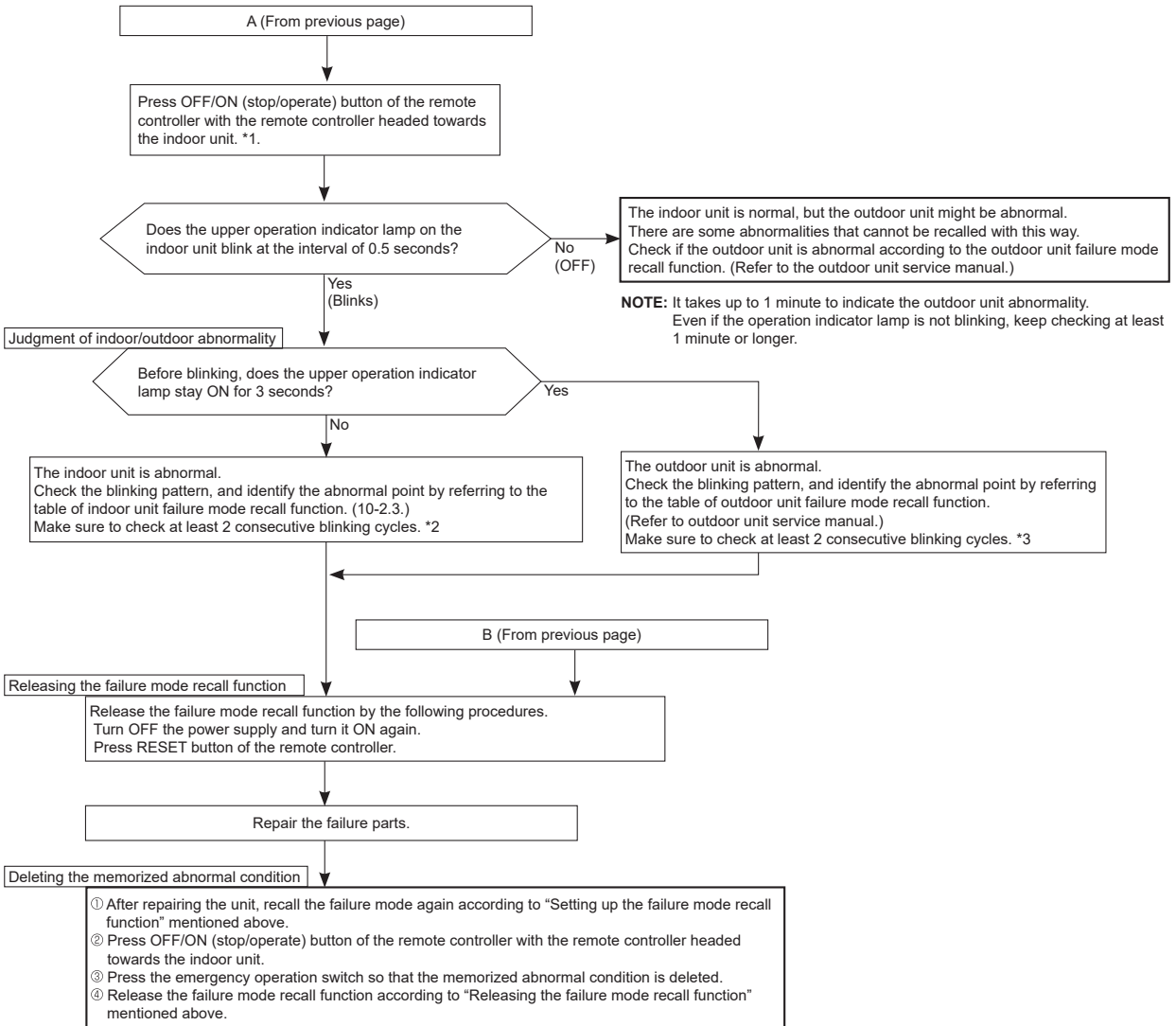
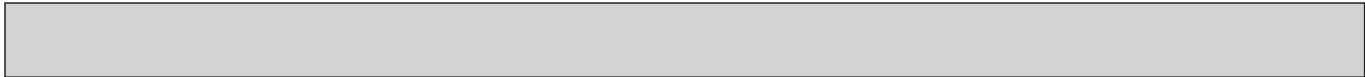

NOTE: It takes up to 1 minute to indicate the outdoor unit abnormality. Even if the operation indicator lamp is not blinking, keep checking at least 1 minute or longer.

NOTE: 1. Make sure to release the failure mode recall function after it is set up, otherwise the unit cannot operate properly.
2. If the abnormal condition is not deleted from the memory, the last abnormal condition is kept memorized.

*1. Regardless of normal or abnormal condition, a short beep is emitted once the signal is received.
*2. Blinking pattern when the indoor unit is abnormal:

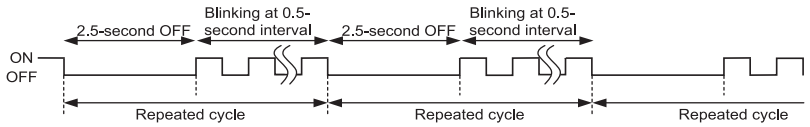

*3. Blinking pattern when the outdoor unit is abnormal:

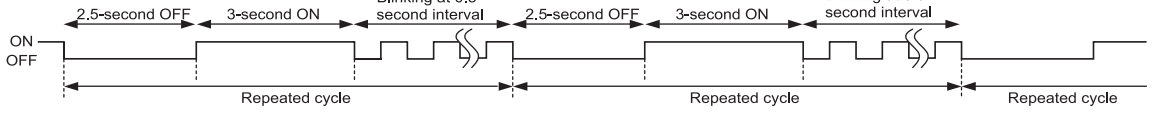

2. Flow chart of error code display mode

This explains how customers can check the error code on their own.
This is included in OPERATING INSTRUCTIONS.

Operational procedure

The remote controller is powered OFF.

Get close to the front of the indoor unit. Point the remote controller at the receiving section of the indoor unit, and keep pressing CHECK with a fine-tipped object. (Figure 1)
"00" is shown in the display. (Figure 2)
Keep pointing the remote controller at the receiving section of the indoor unit until the indoor unit beeps.

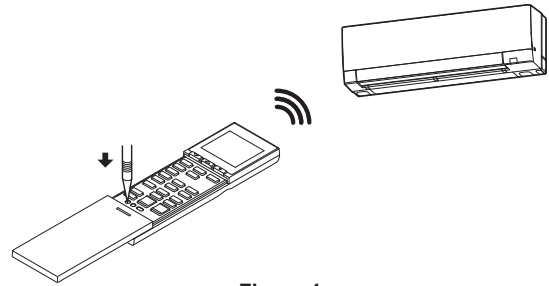

Figure 1

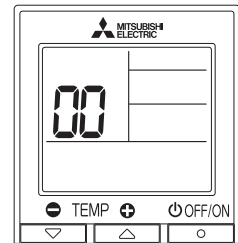
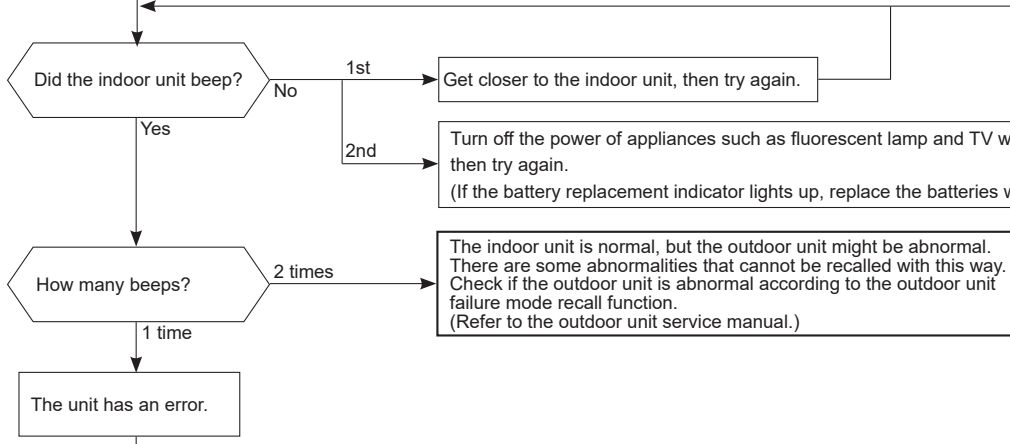

Figure 2

NOTE: Even though the air conditioner operates normally, the memorized indication for the last error appears if it has not been deleted.

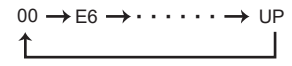
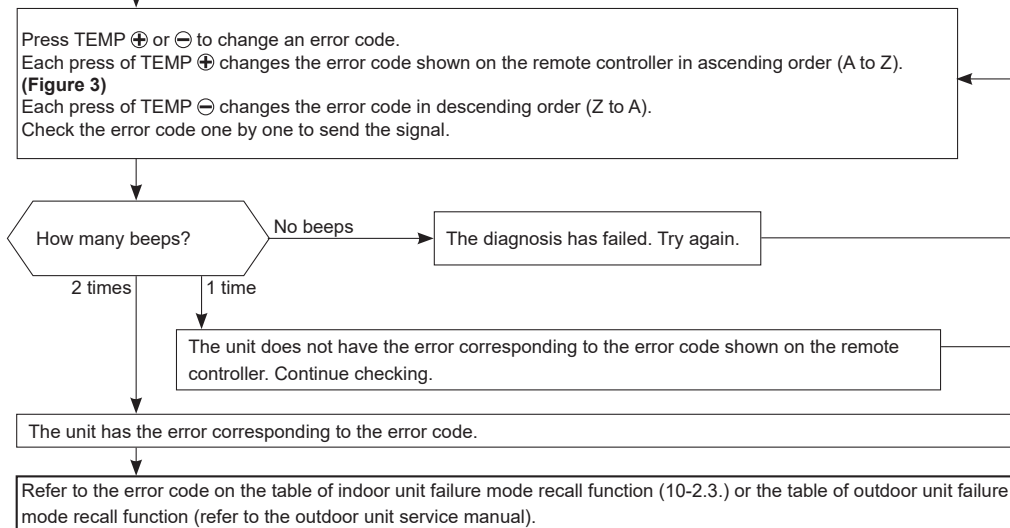

Figure 3

3. Table of indoor unit failure mode recall function

The upper lamp of the operation indicator lamp	Error code	Abnormal point (Failure mode)	Condition	Remedy
Not lit	00	Normal	—	—
1-time blink every 0.5-second	P1	Room temperature thermistor	The room temperature thermistor short or open circuit is detected every 8 seconds during operation.	Refer to the characteristics of the room temperature thermistor (10-7.).
2-time blink 2.5-second OFF	P2	Indoor coil thermistor	The indoor coil thermistor short or open circuit is detected every 8 seconds during operation.	Refer to the characteristics of the main indoor coil thermistor, the sub indoor coil thermistor (10-7.).
	P9			
3-time blink 2.5-second OFF	E6	Serial signal	The serial signal from outdoor unit is not received for a maximum of 6 minutes.	Refer to 10-6.Ⓒ “How to check miswiring and serial signal error”.
	E7			
4-time blink 2.5-second OFF	P4	Drain sensor	CN1S1 is open over 3 minutes.	Check CN1S1.
7-time blink 2.5-second OFF	EE	Combination of indoor and outdoor units	The refrigerant types specified for the indoor and outdoor units do not match.	The refrigerant types specified for the indoor and outdoor units do not match.
11-time blink 2.5-second OFF	Pb	Indoor fan motor	The rotational frequency feedback signal is not emitted for 12 seconds after the indoor fan motor is operated.	Refer to 10-6.Ⓐ “Check of indoor fan motor”.
12-time blink 2.5-second OFF	Fb	Indoor control system	It cannot properly read data in the nonvolatile memory of the indoor electronic control P.C. board.	Replace the indoor electronic control P.C. board. “EE” error may be detected together with “Fb” error for the outdoor unit. When the indoor and outdoor units are connected in the allowed combination, respond only to “Fb” error.
14-time blink 2.5-second OFF 3-second ON	FH	Refrigerant sensor	The refrigerant sensor mounted on the indoor unit does not work. The refrigerant sensor is not connected properly or the wire is broken.	Connect the connector of the refrigerant sensor properly. Replace the refrigerant sensor.
14-time blink 2.5-second OFF 3-second ON	FL	Refrigerant leakage (Sensor detection)	<ol style="list-style-type: none"> 1. Refrigerant leaks from the piping or the heat exchanger in the indoor unit. 2. The following items are used around the indoor unit. <ul style="list-style-type: none"> • Spray (LP gas including Freon, and whose main ingredient is propane and butane) • Aerosol insecticide (including ethanol) • Air spray painting (including dichloromethane) • Charcoal (charcoal fire) • Chemicals (such as ethanol) 	<ul style="list-style-type: none"> • Open the window to ventilate the room. After FAN operation is finished, turn off the breaker. (FAN operation will continue for about 7 hours.) • Check the indoor unit to detect the part where refrigerant leaks. • Repair the part where refrigerant leaks. • Turn on the breaker again. • Replace the refrigerant sensor if the problem is not fixed.

NOTE: Blinking patterns of this mode differ from the ones of TROUBLESHOOTING CHECK TABLE (10-4.).

10-3. INSTRUCTION OF TROUBLESHOOTING

1. Check of the unit.

*1 "Test Run operation" means the operation within 30 minutes after the emergency operation switch is pressed.

*2 There is possibility that diesel explosion may occur due to the air mixed in the refrigerant circuit. First, ensure that there are no leakage points on the valves, flare connections, etc. that allow the air to flow into the refrigerant circuit, or no blockage points (e.g. clogged or closed valves) in the refrigerant circuit that cause an increase in pressure. If there is no abnormal point like above and the system operates cooling and heating modes normally, the indoor thermistor might have a problem, resulting in false detection. Check both the indoor coil thermistor and the room temperature thermistor, and replace faulty thermistor(s), if any.

NOTE: Do not start the operation again without repair to prevent hazards.

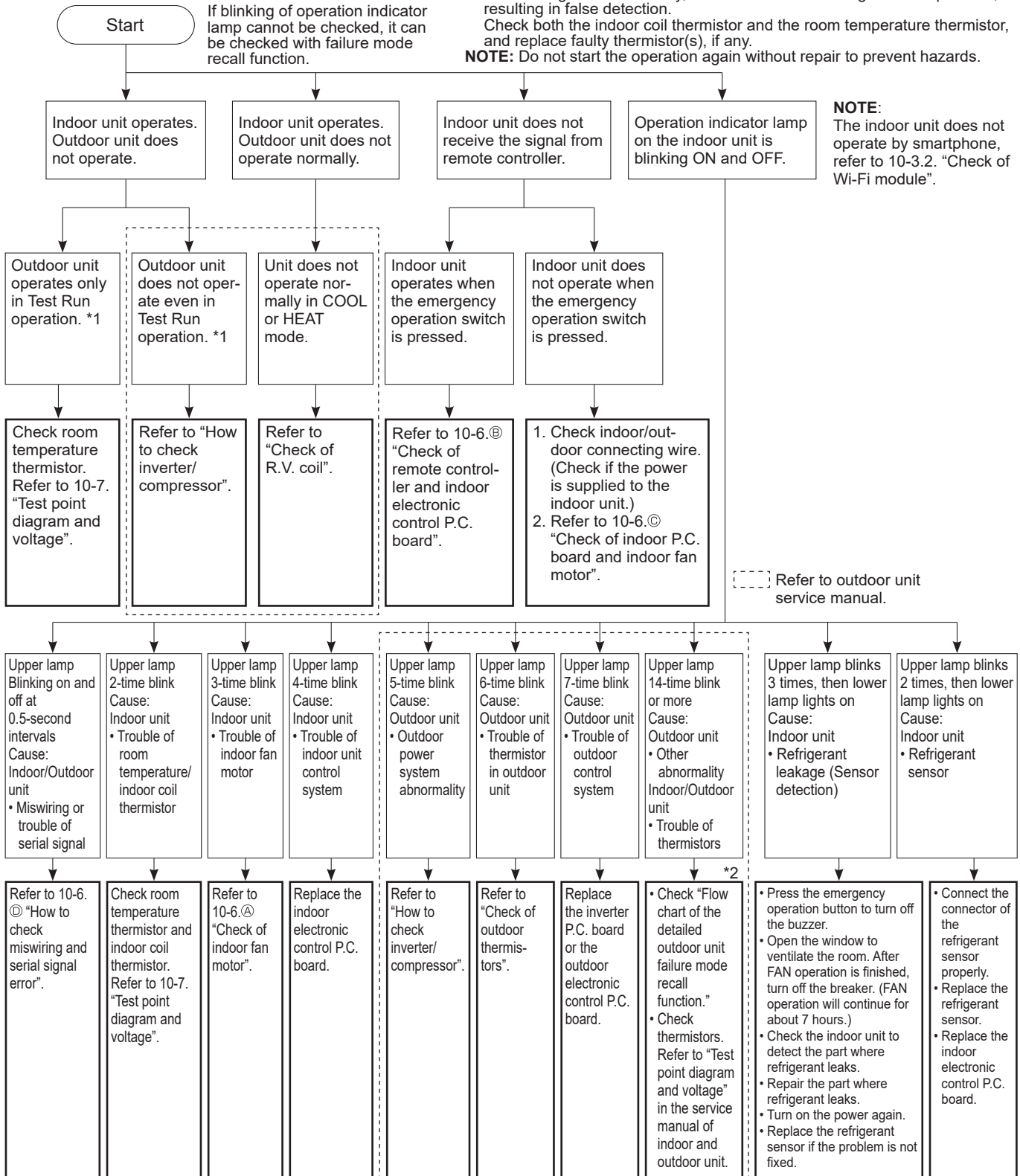

2. Check of wireless LAN module

Follow the procedure below if the air conditioner cannot be monitored or controlled with a device such as a smartphone.

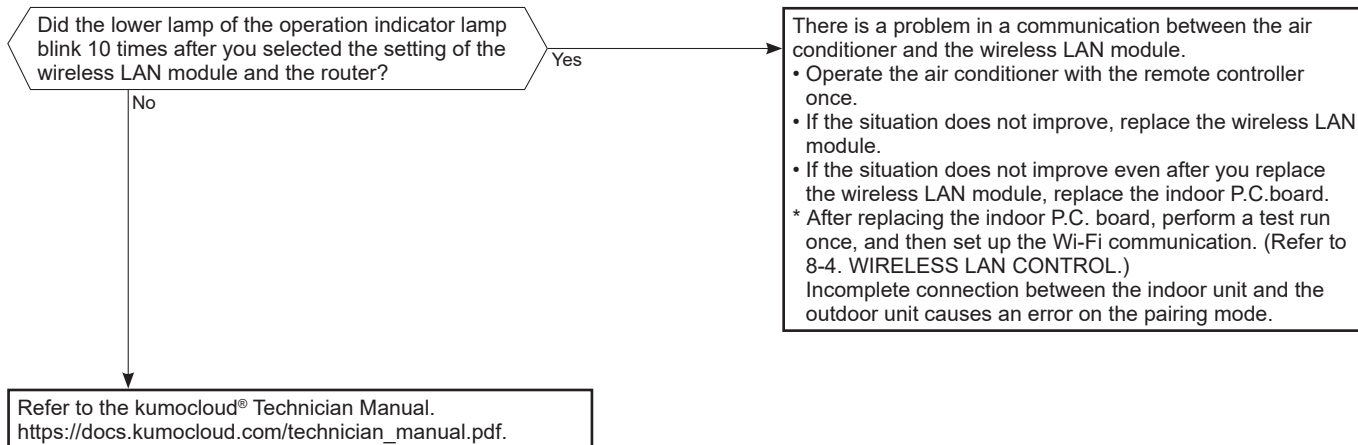

10-4. TROUBLESHOOTING CHECK TABLE

Before taking measures, make sure that the symptom reappears for accurate troubleshooting.

When the indoor unit has started operation and detected an abnormality of the following condition (the first detection after the power ON), the indoor fan motor turns OFF and the operation indicator lamp blinks.

• The following indicator applies regardless of shape of the indication.

Operation indicator







































● Lit
 ⚙️ Blinking
 ○ Not lit

No.	Abnormal point	Operation indicator lamp	Symptom	Condition	Remedy
1	Miswiring or serial signal	Upper lamp blinks. 0.5-second ON ●○●○●○●○ 0.5-second OFF	Indoor unit and outdoor unit do not operate.	The serial signal from the outdoor unit is not received for 6 minutes.	• Refer to 10-6. ③ “How to check miswiring and serial signal error”..
2	Indoor coil thermistor Room temperature thermistor	Upper lamp blinks. 2-time blink ●○●○●○●○●○●○ 2.5-second OFF		The indoor coil or the room temperature thermistor is short or open circuit.	• Refer to the characteristics of indoor coil thermistor, and the room temperature thermistor (10-7.).
3	Indoor fan motor	Upper lamp blinks. 3-time blink ●○●○●○●○●○●○●○●○ 2.5-second OFF		The rotational frequency feedback signal is not emitted during the indoor fan operation.	• Refer to 10-6. ④ “Check of indoor fan motor”.
4	Indoor control system	Upper lamp blinks. 4-time blink ●○●○●○●○●○●○●○●○●○ 2.5-second OFF		It cannot properly read data in the non-volatile memory of the indoor electronic control P.C. board.	• Replace the indoor electronic control P.C. board. • “EE” error may be detected together with “Fb” error for the outdoor unit. When the indoor and outdoor units are connected in the allowed combination, respond only to “Fb” error.
5	Outdoor power system	Upper lamp blinks. 5-time blink ●○●○●○●○●○●○●○●○●○ 2.5-second OFF		It consecutively occurs 3 times that the compressor stops for overcurrent protection or startup failure protection within 1 minute after startup.	• Refer to “How to check of inverter/compressor”. Refer to outdoor unit service manual • Check the stop valve.
6	Outdoor thermistors	Upper lamp blinks. 6-time blink ●○●○●○●○●○●○●○●○●○ 2.5-second OFF		The outdoor thermistors short or open circuit during the compressor operation.	• Refer to “Check of outdoor thermistor”. Refer to outdoor unit service manual.
7	Outdoor control system	Upper lamp blinks. 7-time blink ●○●○●○●○●○●○●○●○●○ 2.5-second OFF		It cannot properly read data in the non-volatile memory of the inverter P.C. board or the outdoor electronic control P.C. board.	• Replace the inverter P.C. board or the outdoor electronic control P.C. board. Refer to outdoor unit service manual.
8	Indoor electronic control P.C. board	Upper lamp blinks 9-time blink ●○●○●○●○●○●○●○●○●○ ○●○●○●○●○ 2.5-second OFF		CN1S1 is open over 3 minutes.	• Check CN1S1.
9	Other abnormality *1	Upper lamp blinks. 14-time blink or more ●○●○●○●○●○●○●○●○●○●○●○●○●○ ○●○●○●○●○ 2.5-second OFF		An abnormality other than the above is detected. An abnormality of the indoor thermistors, the defrost thermistor or ambient temperature thermistor is detected.	• Check the stop valve. • Check the 4-way valve. • Check the abnormality in detail using the failure mode recall function for outdoor unit. • Refer to TEST POINT DIAGRAM AND VOLTAGE* on the service manual of indoor and outdoor unit for the characteristics of the thermistors. (Do not start the operation again without repair to prevent hazards.)
10	Outdoor control system	Upper lamp lights up. ●		Outdoor unit does not operate	It cannot properly read data in the non-volatile memory of the inverter P.C. board or the outdoor electronic control P.C. board.

*1 Refer to *2 on 10-3. INSTRUCTION OF TROUBLESHOOTING.



No.	Abnormal point	Operation indicator lamp	Symptom	Condition	Remedy
11	Refrigerant sensor	Upper lamp blinks 2 times, then Lower lamp lights on. Upper lamp                                     			

10-5. TROUBLESHOOTING CRITERION OF MAIN PARTS

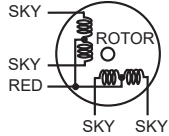
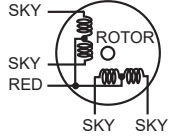
Part name	Check method and criterion	Figure										
Room temperature thermistor (RT11)	Measure the resistance with a multimeter.											
Indoor coil thermistor (RT12 (MAIN), RT13 (SUB))	Refer to 10-7. "Test point diagram and voltage", "Indoor electronic control P.C. board", the chart of thermistor.											
Indoor fan motor (MF)	Check 10-6. ㉠.											
MSZ-GX06/09/12/15NL MSY-GX09/12/15NL Horizontal vane motor (MV1, MV2) Vertical vane motor (MV3)	Measure the resistance between the terminals with a multimeter. (Part temperature 50 – 86°F (10 – 30°C))											
	<table border="1"> <thead> <tr> <th></th> <th>Color of the lead wire</th> <th>Normal</th> </tr> </thead> <tbody> <tr> <td>Horizontal vane motor (MV1)</td> <td rowspan="3">RED – SKY*</td> <td>205 – 289 Ω</td> </tr> <tr> <td>Horizontal vane motor (MV2)</td> <td>236 – 346 Ω</td> </tr> <tr> <td>Vertical vane motor (MV3)</td> <td>205 – 289 Ω</td> </tr> </tbody> </table>			Color of the lead wire	Normal	Horizontal vane motor (MV1)	RED – SKY*	205 – 289 Ω	Horizontal vane motor (MV2)	236 – 346 Ω	Vertical vane motor (MV3)	205 – 289 Ω
	Color of the lead wire		Normal									
Horizontal vane motor (MV1)	RED – SKY*		205 – 289 Ω									
Horizontal vane motor (MV2)		236 – 346 Ω										
Vertical vane motor (MV3)		205 – 289 Ω										
MSZ-GX18/24/30/36NL MSY-GX18/24/30/36NL Horizontal vane motor (MV1, MV2) Vertical vane motor (MV3, MV4)	Measure the resistance between the terminals with a multimeter. (Part temperature 50 – 86°F (10 – 30°C))											
	<table border="1"> <thead> <tr> <th></th> <th>Color of the lead wire</th> <th>Normal</th> </tr> </thead> <tbody> <tr> <td>Horizontal vane motor (MV1, MV2)</td> <td rowspan="2">RED – SKY*</td> <td>205 – 289 Ω</td> </tr> <tr> <td>Vertical vane motor (MV3, MV4)</td> <td>246 – 347 Ω</td> </tr> </tbody> </table>			Color of the lead wire	Normal	Horizontal vane motor (MV1, MV2)	RED – SKY*	205 – 289 Ω	Vertical vane motor (MV3, MV4)	246 – 347 Ω		
	Color of the lead wire		Normal									
Horizontal vane motor (MV1, MV2)	RED – SKY*		205 – 289 Ω									
Vertical vane motor (MV3, MV4)		246 – 347 Ω										

*SKY = SKY BLUE

10-6. TROUBLESHOOTING FLOW

A Check of indoor fan motor

The indoor fan motor error has occurred, and the indoor fan does not operate.

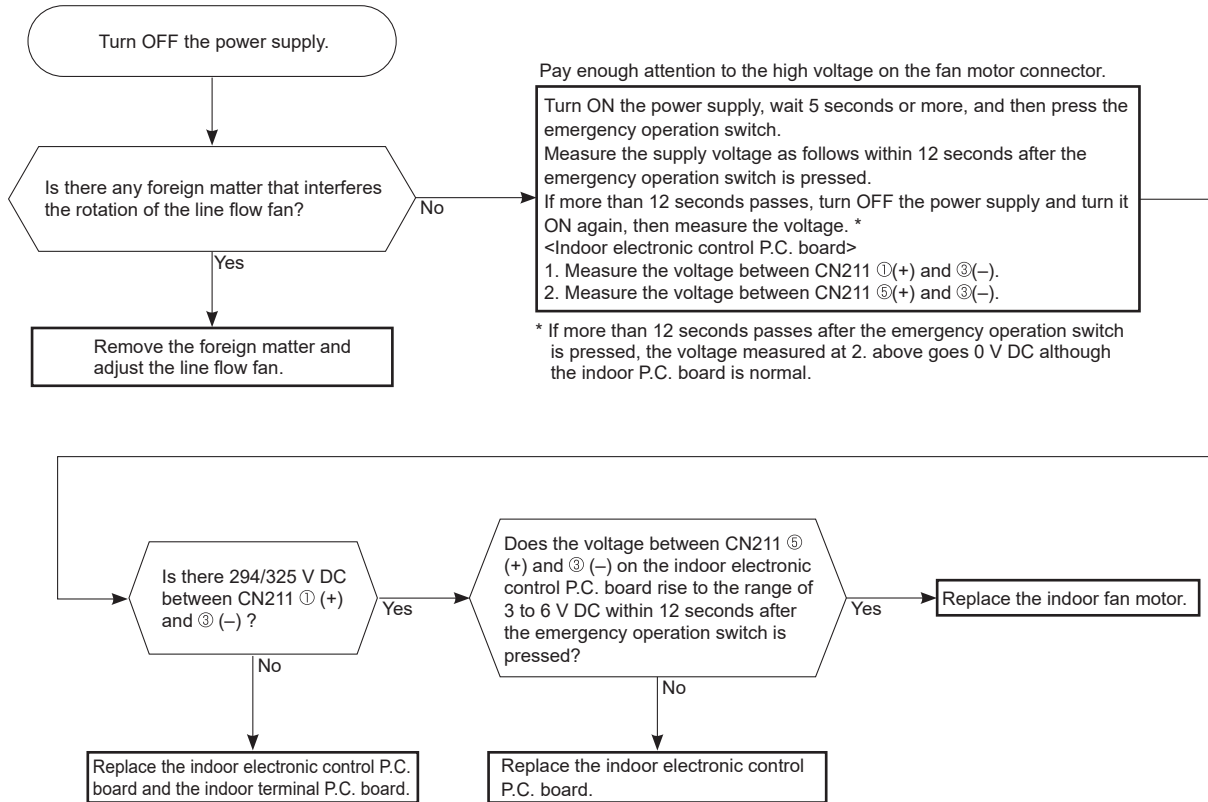

The indoor fan motor error has occurred, and the indoor fan repeats "12-second ON and 30-second OFF" 3 times, and then stops.

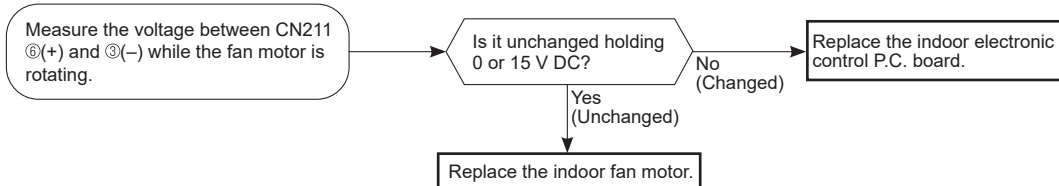

B Check of remote controller and receiver P.C. board

Check if the remote controller is exclusive for this air conditioner.

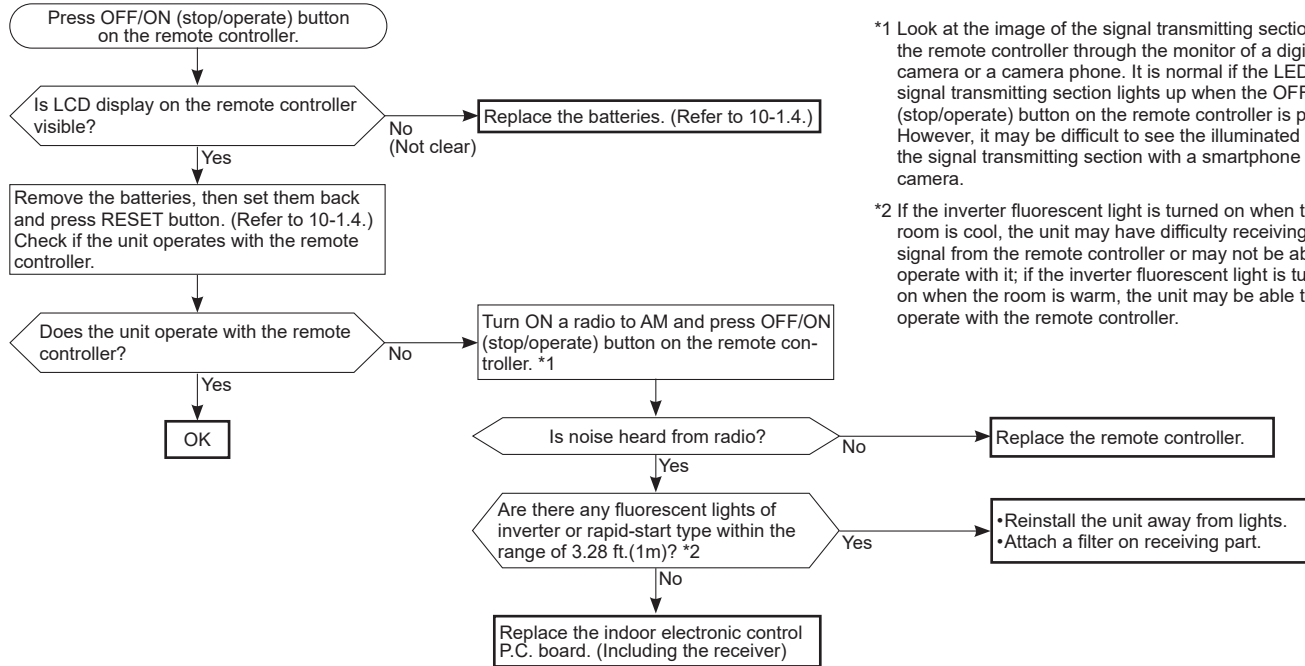

*1 Look at the image of the signal transmitting section of the remote controller through the monitor of a digital camera or a camera phone. It is normal if the LED of the signal transmitting section lights up when the OFF/ON (stop/operate) button on the remote controller is pressed. However, it may be difficult to see the illuminated LED of the signal transmitting section with a smartphone camera.

*2 If the inverter fluorescent light is turned on when the room is cool, the unit may have difficulty receiving the signal from the remote controller or may not be able to operate with it; if the inverter fluorescent light is turned on when the room is warm, the unit may be able to operate with the remote controller.

© Check of indoor electronic control P.C. board and indoor fan motor

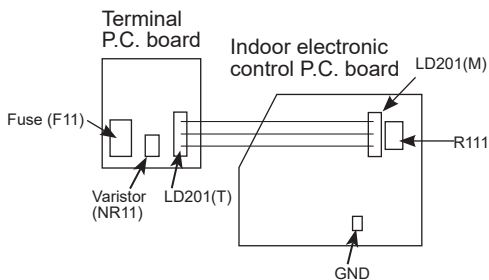
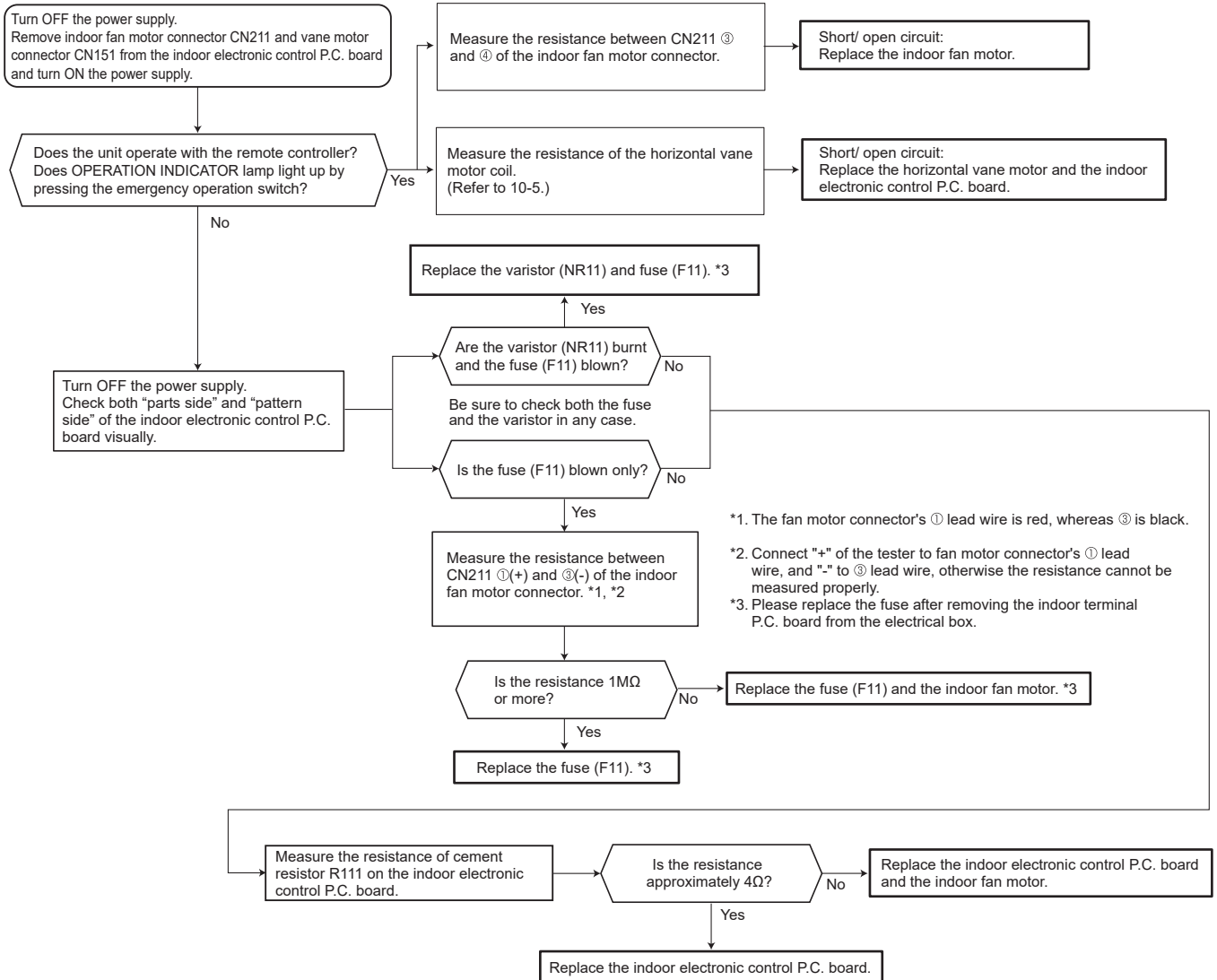

D How to check miswiring and serial signal error

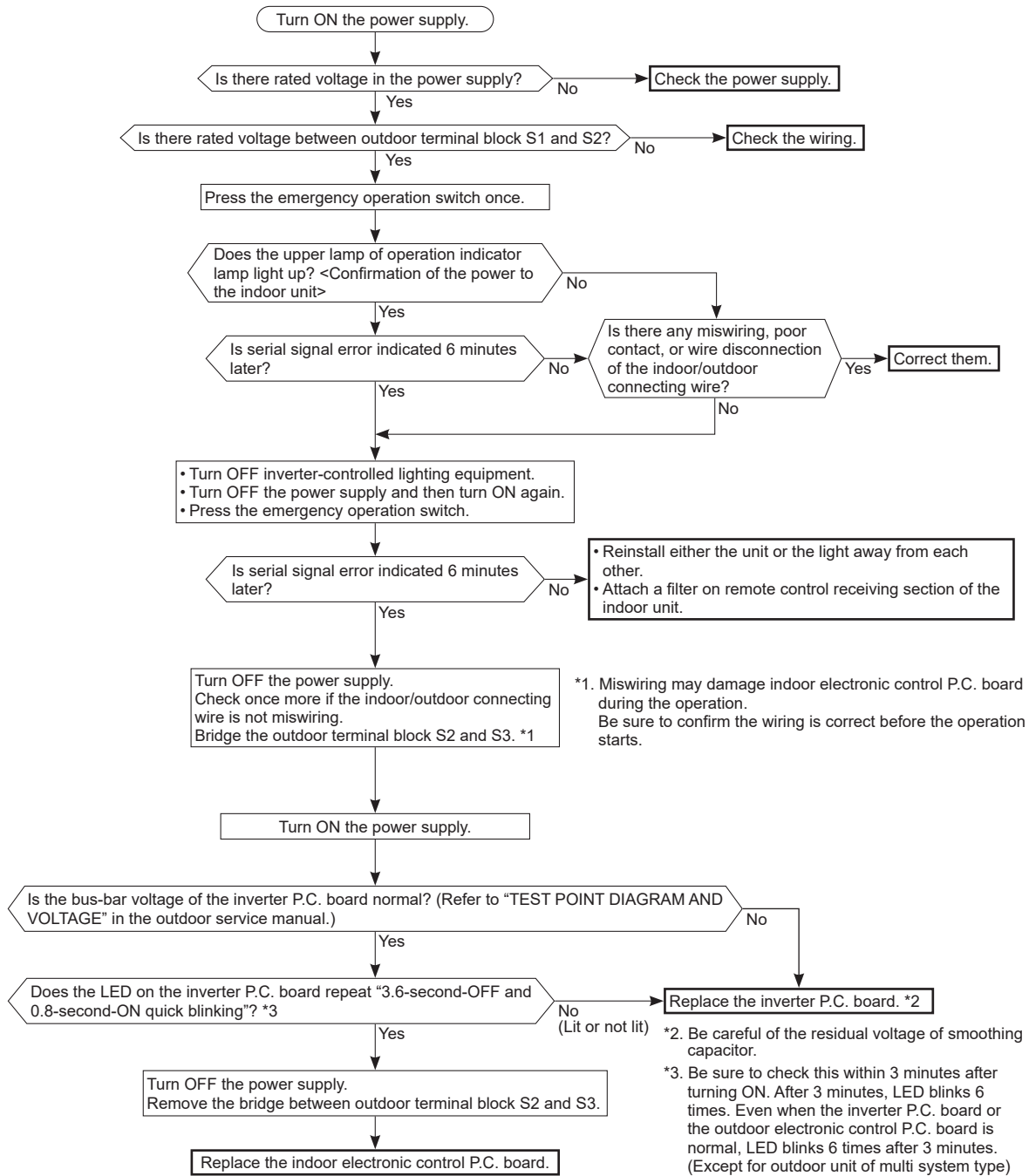

E Electromagnetic noise enters into TV sets or radios

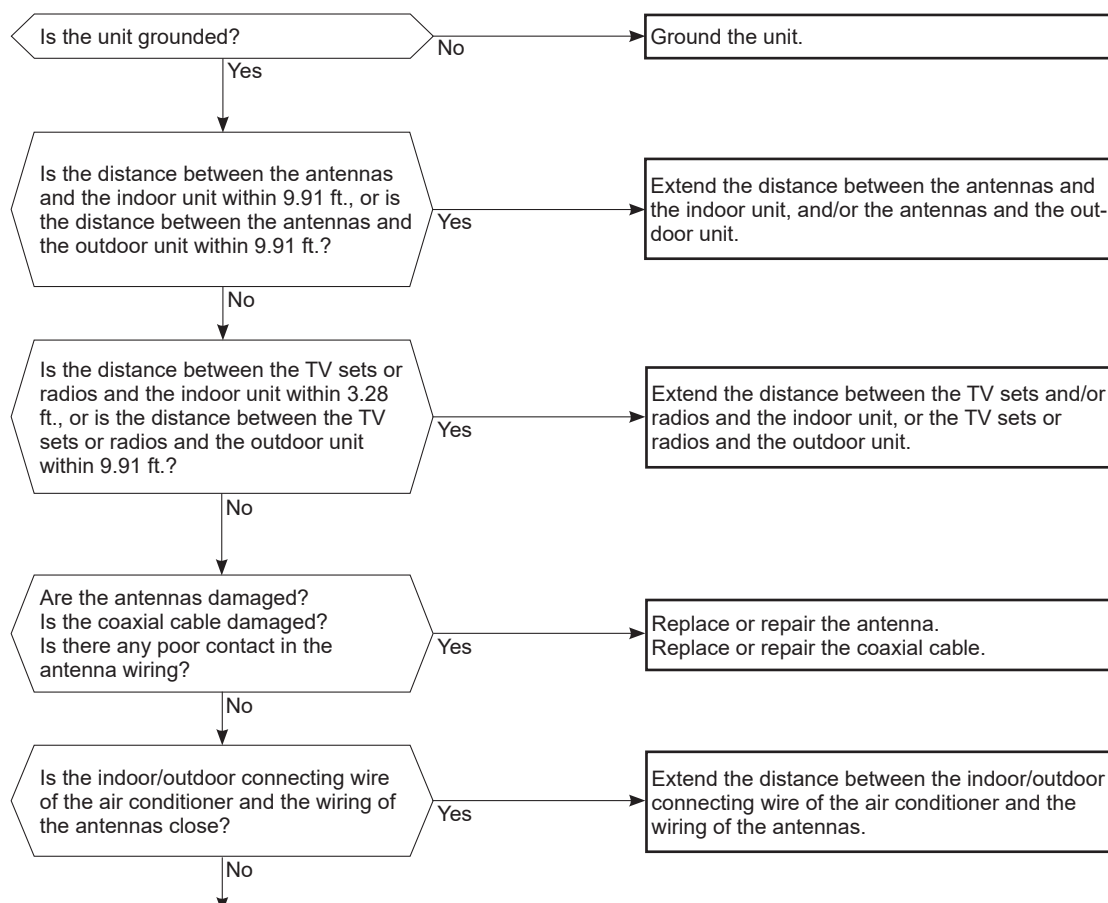

10-7. TEST POINT DIAGRAM AND VOLTAGE

Indoor terminal P.C. board, Indoor electronic control P.C. board, Receiver P.C. board, Display P.C. board, Switch/buzzer P.C. board

MSZ-GX06NL MSZ-GX09NL MSZ-GX12NL MSZ-GX15NL
 MSY-GX09NL MSY-GX12NL MSY-GX15NL

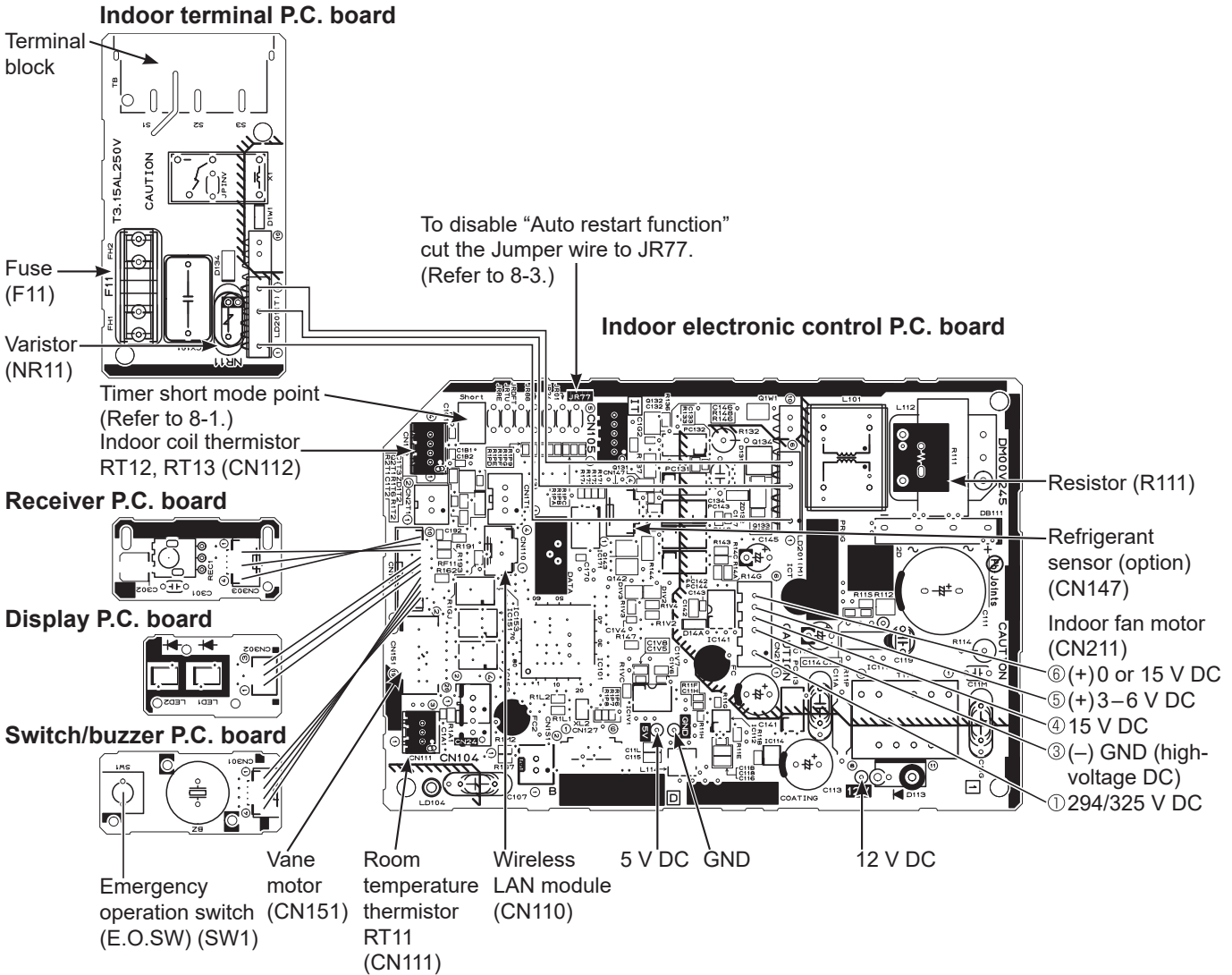

Indoor terminal P.C. board, Indoor electronic control P.C. board, Receiver P.C. board, Display P.C. board, Switch/buzzer P.C. board

MSZ-GX18NL MSZ-GX24NL MSZ-GX30NL MSZ-GX36NL
 MSY-GX18NL MSY-GX24NL MSY-GX30NL MSY-GX36NL

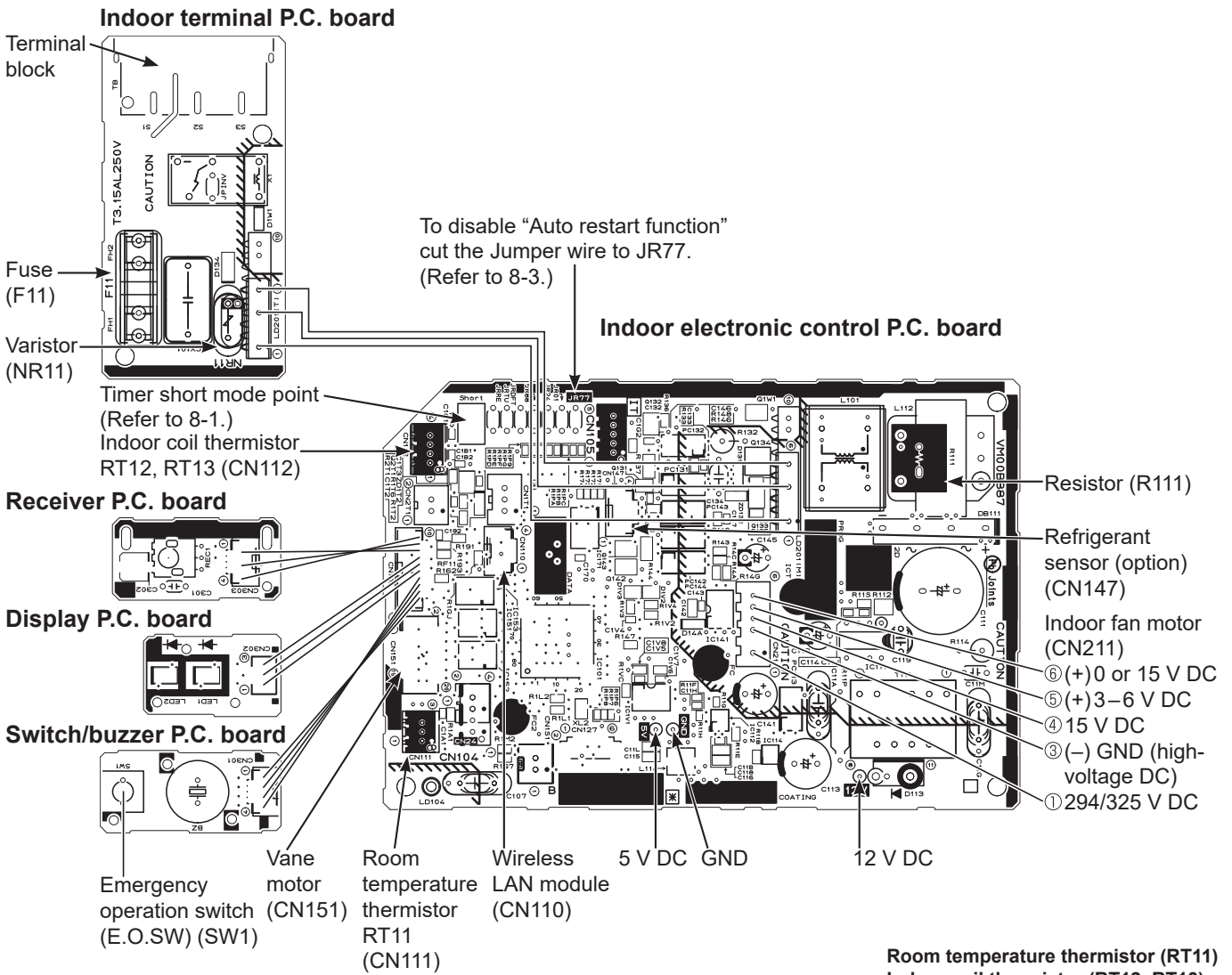

Room temperature thermistor (RT11)
 Indoor coil thermistor (RT12, RT13)

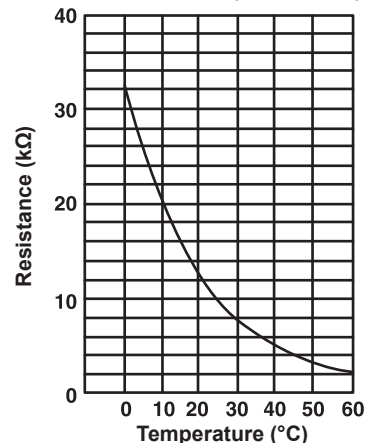

<Detaching method of the terminal with locking mechanism>

The terminal which has the locking mechanism can be detached as shown below.

There are 2 types of the terminal with locking mechanism.

The terminal without locking mechanism can be detached by pulling it out.

Check the shape of the terminal before detaching.

(1) Slide the sleeve and check if there is a locking lever or not.

(2) The terminal with this connector shown below has the locking mechanism.

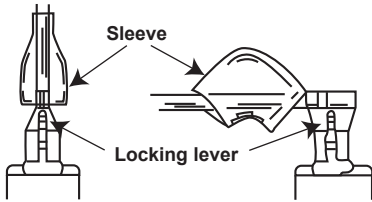

- ① Slide the sleeve.
- ② Pull the terminal while pushing the locking lever.

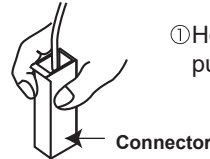

- ① Hold the sleeve, and pull out the terminal slowly.

**11-1. MSZ-GX06NL MSZ-GX09NL MSZ-GX12NL MSZ-GX15NL
MSY-GX09NL MSY-GX12NL MSY-GX15NL**

NOTE: Turn OFF the power supply before disassembly.

————>: Indicates the visible parts in the photos/figures.
----->: Indicates the invisible parts in the photos/figures.

OPERATING PROCEDURE	PHOTOS/FIGURES
<p>1. Removing the front panel and the panels (R/L/F/U) Removing the front panel (Photo 1, Figure 1) (1) Lift the front panel until a “click” is heard. (2) Hold the hinges and pull to remove the front panel (Figure 1). (3) Remove the horizontal vanes. Unlock the rocks of the horizontal vane upper (3 points). Pull and remove the horizontal vane upper to the side. Remove the horizontal vane lower by the same procedure.(2 points)</p>	<p>Photo 1</p> <p>Figure 1</p>

OPERATING PROCEDURE

Removing the panel (R) (Photos 1, 2, 3, Figure 1)

- (1) Remove the front panel and the horizontal vanes (U) (L). Unlock the locks of the horizontal vane upper (3 points). Pull and remove the horizontal vane upper to the side. Remove the horizontal vane lower by the same procedure (2 points).
- (2) Remove the screw cap on the panel (R), and the screw.
- (3) Remove the 2 screws of the panel (R), and pull the top of the panel (R) toward you to remove.

Removing the panel (L) (Photos 1, 2, 3, Figure 1)

- (1) Remove the front panel and the horizontal vanes (U) (L). Unlock the rocks of the horizontal vane upper (3 points). Pull and remove the horizontal vane upper to the side. Remove the horizontal vane lower by the same procedure (2 points).
- (2) Remove the screw cap on the panel (L), and the screw.
- (3) Remove the screw of the panel (L), and pull the top of the panel (L) toward you to remove.

Removing the panel (F) (Photos 1, 2, 3, Figure 1)

- (1) Remove the front panel and the horizontal vanes (U) (L). Unlock the rocks of the horizontal vane upper (3 points). Pull and remove the horizontal vane upper to the side. Remove the horizontal vane lower by the same procedure (2 points).
- (2) Remove the panels (R) (L).
- (3) Remove the Wi-Fi interface on the right side of the panel (F). Pull out its cable, and remove the cable tie (Refer to section 2).
- (4) Remove the panel (F) from the bottom to the top.

Removing the panel (U) (Photo 3, Figure 1)

- (1) Remove the front panel and the horizontal vanes (U) (L). Unlock the rocks of the horizontal vane upper (3 points). Pull and remove the horizontal vane upper to the side. Remove the horizontal vane lower by the same procedure (2 points).
- (2) Remove the panels (R) (L).
- (3) Remove the center hook of the panel (U), and pull it toward you to remove.

PHOTOS/FIGURES

Photo 2



Photo 3

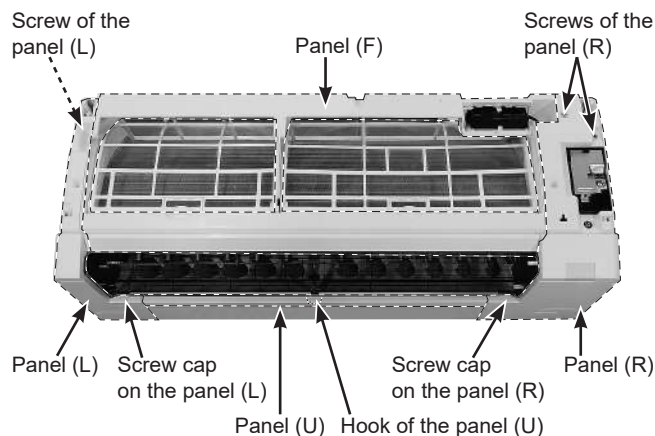

OPERATING PROCEDURE

2. Removing the Wi-Fi interface (Photos 4, 5)

- (1) Remove the front panel and the horizontal vanes (U) (L) (Refer to section 1.)
- (2) Remove the panels (R) (L) (U).
- (3) Remove the screw of the V.A. clamp and remove the V.A. clamp.
- (4) Disconnect the indoor/outdoor connecting wire from the terminal block.
- (5) Remove the screw of the electrical cover and remove the electrical cover.
- (6) Remove the refrigerant sensor holder. (Photo 5)
- (7) Unhook the catch on the left side of the display P.C. board holder. Pull the display P.C. board holder as if opening the door at 90 degrees.
- (8) Remove the Wi-Fi interface on the right side of the panel (F). Pull out its cable, and remove the cable tie, then remove the panel (F).
- (9) Disconnect the following connector (Photo 8):
<Indoor electronic control P.C. board>
CN110 (Wi-Fi interface)
- (10) Remove the lead wire of the Wi-Fi interface from the hook of the cable guide ©. (Photo 8)

How to install the Wi-Fi interface (Photo 4)

NOTE: Install the Wi-Fi interface before installing the panel (R).

- (1) Install the panel (F).
- (2) Attach the Wi-Fi interface.
- (3) Fasten the cable of Wi-Fi interface to the part ① of the panel (F) with a cable tie.
- (4) Stow the cable of Wi-Fi interface in the area ②.
- (5) Attach the lead wire of the Wi-Fi interface to the hook of the cable guide ©. (Photo 8)
- (6) Connect the connector of Wi-Fi interface (CN110) to the indoor electronic control P.C. board.
- (7) Close the display and P.C. board holder.
- (8) Attach the refrigerant sensor holder.
- (9) Install the electrical cover, and install the screw in the electrical cover.
- (10) Connect the indoor/outdoor connecting wire from the terminal block.
- (11) Install the V.A. clamp, and install the screw in the V.A. clamp.
- (12) Install the panel (U).
- (13) Install the panel (R).
- (14) Install the panel (L).

PHOTOS/FIGURES

Photo 4

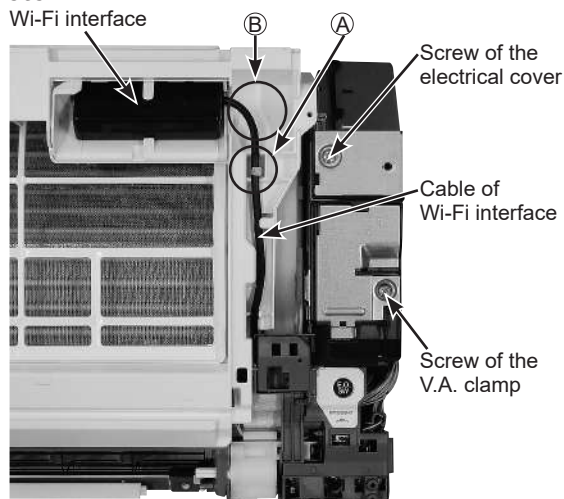
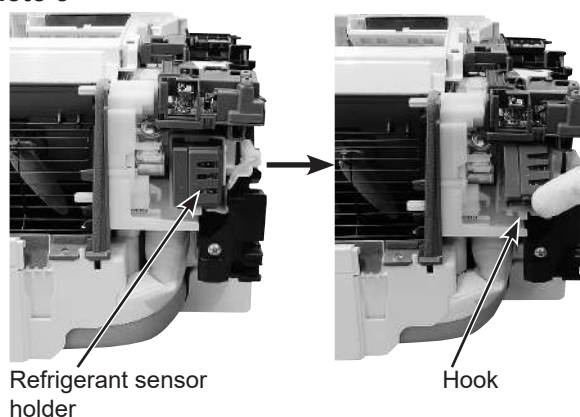

Photo 5



OPERATING PROCEDURE

3. Removing the indoor electrical box (Photos 6, 7, 8)

- (1) Remove the front panel, the horizontal vanes (U) (L), the panels (R) (L) (U) (F) and the Wi-Fi interface.
- (2) Remove the indoor/outdoor connecting wire, electrical cover (Refer to section 2.)
- (3) Remove the screw of the conduit plate and remove the conduit plate.
- (4) Remove the screw of the electrical box.
- (5) Remove the screw of the electrical cover and remove the electrical cover.
- (6) Disconnect the following connector (Photo 8):
<Indoor electronic control P.C. board>
CN110 (Wi-Fi interface)
CN151 (Vane motors)
CN211 (Indoor fan motor)
CN112 (Indoor coil thermistors)
CN147 (Refrigerant sensor, option) **(MSZ only)**
- (7) Remove refrigerant sensor holder.
- (8) Unhook the catch on the left side of the display P.C. board holder. Pull the display P.C. board holder as if opening the door at 90 degrees.
- (9) Remove the lead wires of indoor coil thermistor from the hooks of the electrical box.
- (10) Remove the earth wire connected to the indoor heat exchanger from the electrical box.
- (11) Remove the electrical box.

4. Removing the indoor terminal P.C. board, the switch/buzzer P.C. board, the display P.C. board, the receiver P.C. board and the indoor electronic control P.C. board

- (1) Remove the indoor electrical box (Refer to section 3).
- (2) Remove the screw of the terminal block (Photo 5).
- (3) Remove the earth wire connected to the electrical box from the indoor electronic control P.C. board.
- (4) Remove the indoor terminal P.C. board.
- (4) Remove refrigerant sensor holder.
- (5) Pull the display P.C. board holder as if opening the door at 90 degrees. Remove the display P.C. board holder from the axial rod on the electrical box.
- (6) Open the rear cover of the display and receiver P.C. board holder.
- (7) Remove the switch/ buzzer P.C. board, the display P.C. board and the receiver P.C. board.
- (8) Remove the indoor electronic control P.C. board.

PHOTOS/FIGURES

Photo 6

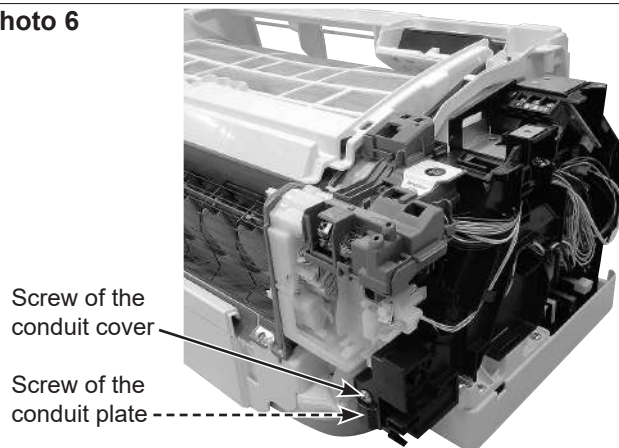

Photo 7

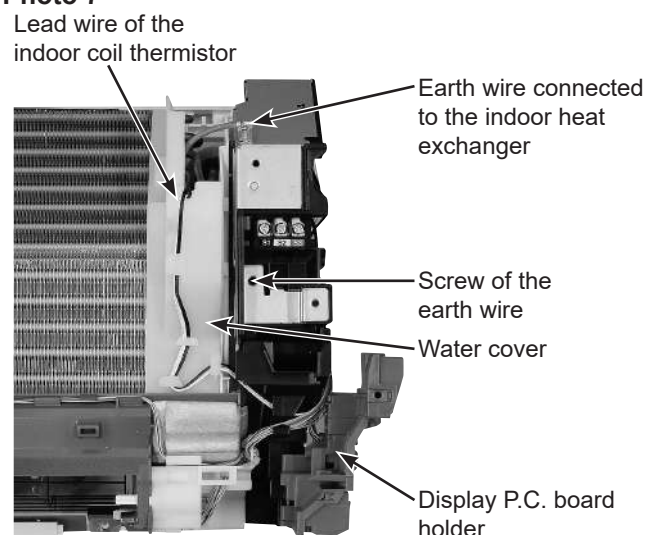
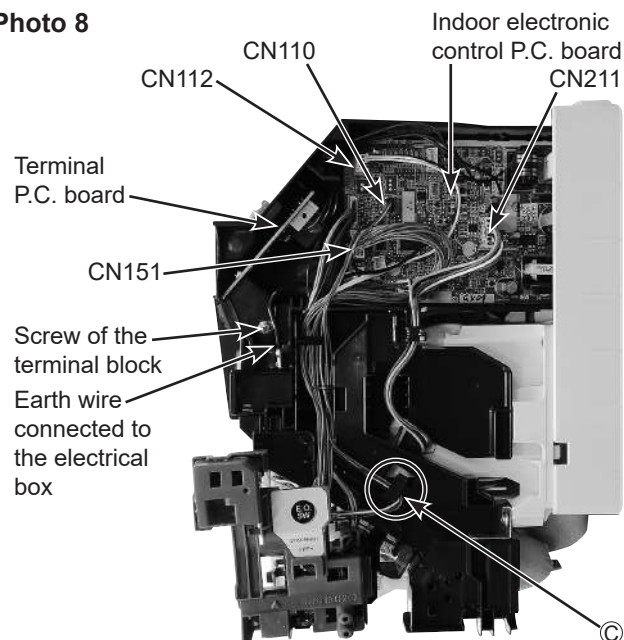

Photo 8



OPERATING PROCEDURE

PHOTOS/FIGURES

5. Removing the nozzle assembly

- (1) Remove the front panel, the horizontal vanes (U) (L), the panels (R) (L) (F) (U), the Wi-Fi interface, the V.A. clamp, and the electrical cover.
- (2) Disconnect the following connector:
<Indoor electronic control P.C. board>
CN151 (Vane motors)
- (3) Remove the refrigerant sensor holder.
- (4) Unhook the catch on the left side of the display P.C. board holder. Pull the display P.C. board holder as if opening the door at 90 degrees. Remove the display P.C. board holder from the axial rod on the electrical box.
- (5) Pull out the drain hose from the nozzle assembly and remove the nozzle assembly.

Photo 9

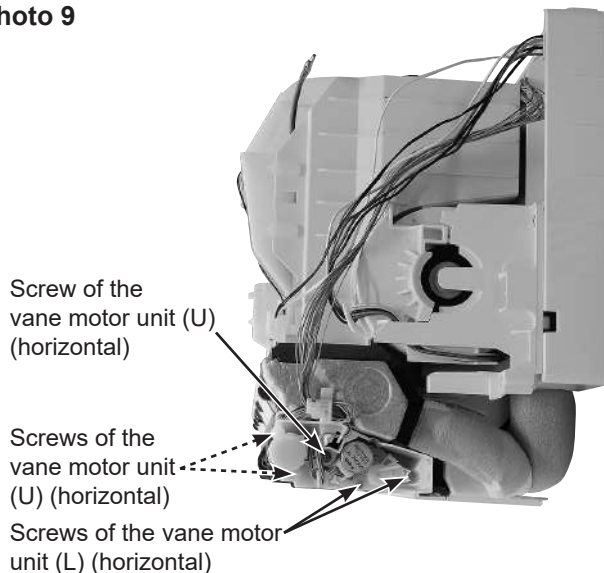

6. Removing the vane motors (U) (L) (horizontal) and the vane motor (vertical)

- (1) Remove the nozzle assembly (refer to section 5).
- (2) Remove the vane motors (U) (L) (horizontal) (Photo 9)
- (3) Remove the 2 screws of the vane motor unit (U) (L) and remove the lead wires of the vane motors (U) (L) (horizontal).
- (4) Remove the screw of the vane motor unit (L) (horizontal), and remove the vane motor unit (L) (horizontal).
- (5) Remove the 2 screws of the vane motor unit (U) (horizontal) from the backside of the vane motor unit (U) (L) (horizontal), and remove the vane motor unit (L) (horizontal).

Removing the vane motor unit (vertical) (Photo 10, 11)

- (6) Remove the crank of the vane motor unit (vertical) from the vane (vertical).
- (7) Remove the 2 screws of the vane motor unit (vertical), and pull the vane motor unit (vertical).
- (8) Remove the 2 screws of the vane motor unit cover (vertical).
- (9) Remove the crank of the vane motor unit (vertical) from the shaft of the vane motor (vertical).
- (10) Remove the vane motor (vertical) from the vane motor unit (vertical).
- (11) Disconnect the connector of vane motor (vertical) from the vane motor (vertical).

Photo 10

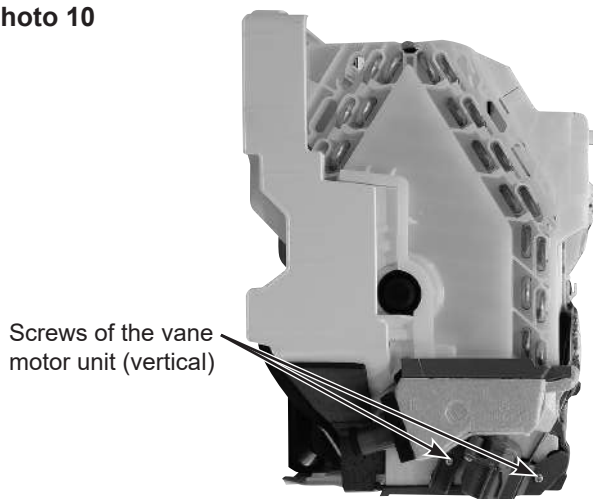
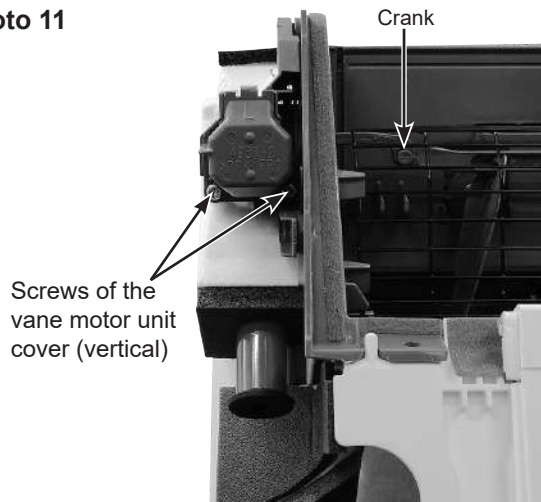

Photo 11



OPERATING PROCEDURE

7. Removing the line flow fan, the indoor fan motor assembly, the indoor coil thermistor (Photo 12, 13, 14)

- (1) Remove the front panel, the horizontal vanes (U) (L), the panels (R) (L) (F) (U), the Wi-Fi interface, the electrical box, and the nozzle assembly.
- (2) Disengage the catches of the water cover, and remove the water cover.
- (3) Loosen the screw inside the right side of the line flow fan (Photo 12).
- (4) Remove the 3 screws of the fan motor assembly. Pull the fan motor assembly slightly toward you, and remove it by pulling to the right (Photo 13).
- (5) Remove the indoor coil thermistor from the heat exchanger.
- (6) Remove the 2 screws of the hairpin holder on the left side of the heat exchanger. Raise the left side of the heat exchanger, and pull the line flow fan to the lower left to remove (Photo 14).
- (7) Disengage the 2 catches on the right side of the heat exchanger, and remove the heat exchanger.

* When attaching the line flow fan, screw the line flow fan so 4 mm gap is provided between the right end of the line flow fan and the right wall of the air passage of the box (Figure 2).

Figure 2

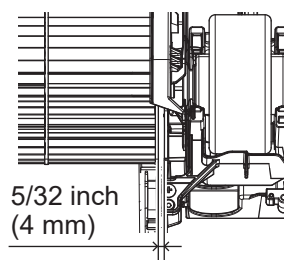

PHOTOS/FIGURES

Photo 12

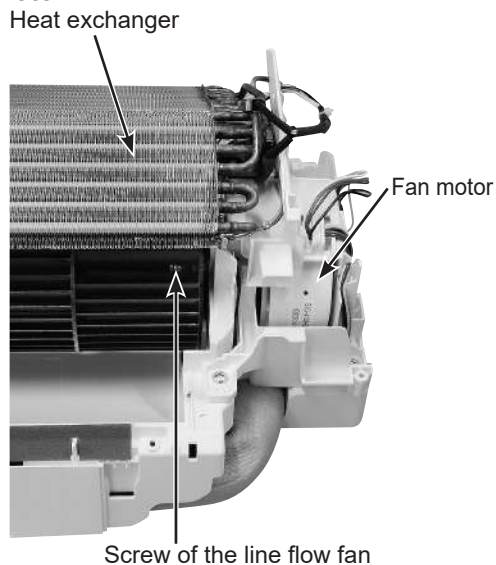

Photo 13

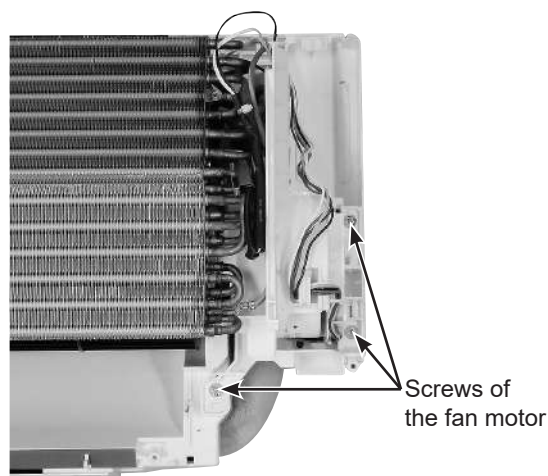
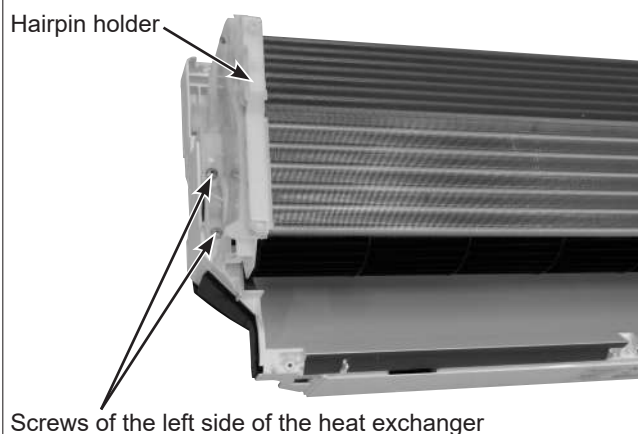
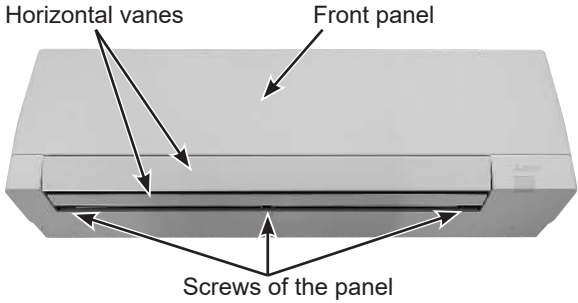
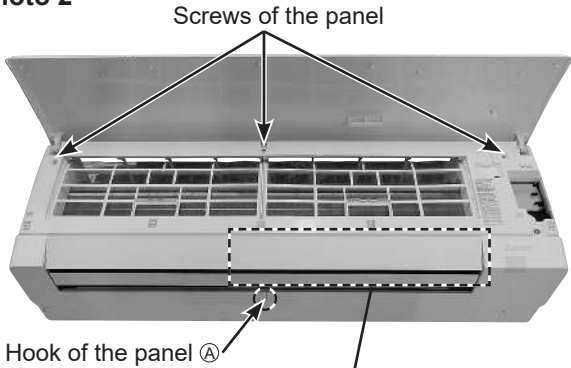



Photo 14



11-2. MSZ-GX18NL MSZ-GX24NL MSZ-GX30NL MSZ-GX36NL
MSY-GX18NL MSY-GX24NL MSY-GX30NL MSY-GX36NL

NOTE: Turn OFF the power supply before disassembly.

OPERATING PROCEDURE	PHOTOS/FIGURES
<p>1. Removing the panel</p> <p>(1) Remove the horizontal vanes. Unlock the locks of the horizontal vane upper (3 points). Pull and remove the horizontal vane upper to the side. Remove the horizontal vane lower by the same procedure.</p> <p>(2) Remove the screw caps from the panel. Remove the front panel. Remove the screws from the panel.</p> <p>(3) Remove the air filter.</p> <p>(4) Unhook the lower part (Ⓐ) of the panel.</p> <p>(5) Hold the lower part of both ends of the panel and pull it slightly toward you, and then remove the panel by pushing it upward.</p>	<p>Photo 1</p>  <p>Horizontal vanes Front panel</p> <p>Screws of the panel</p> <p>Photo 2</p>  <p>Screws of the panel</p> <p>Hook of the panel Ⓐ</p> <p>Photo 3</p> 

OPERATING PROCEDURE

2. Removing the wireless LAN module

- (1) Remove the panel (Refer to section 1) and the right corner box.
- (2) Remove the screw of the V.A. clamp and remove the V.A. clamp.
- (3) Disconnect the indoor/outdoor connecting wire from the terminal block.
- (4) Remove the screw of the electrical cover, and remove the electrical cover.
- (5) Disconnect the following connector (Photo 8):
<Indoor electronic control P.C. board>
CN110 (Wireless LAN module)
- (6) Disengage the catch and remove the wireless LAN module.

How to install the wireless LAN module

- (1) Attach the wireless LAN module.
- (2) Hook the cable of wireless LAN module to the panel (F).
- (3) Connect the connector of CN110 (Wireless LAN module) to the indoor electronic control P.C. board.
- (4) Install the electrical cover, and install the screw in the electrical cover.
- (5) Connect the indoor/outdoor connecting wire to the terminal block.
- (6) Install the V.A. clamp, and install the screw in the V.A. clamp.

PHOTOS/FIGURES

Photo 4

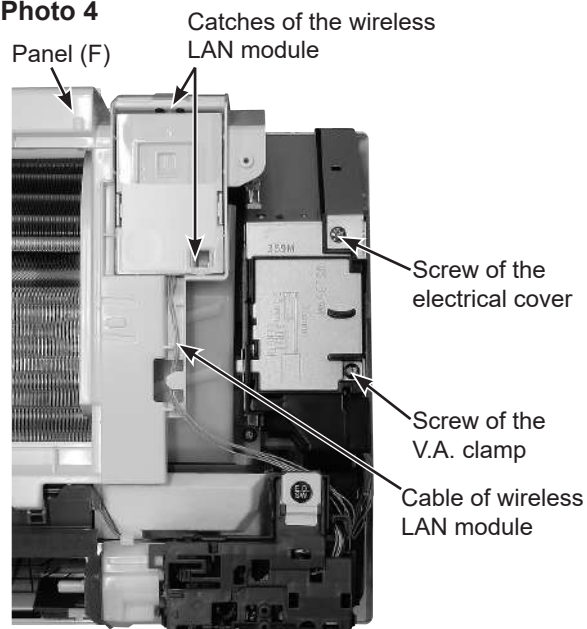
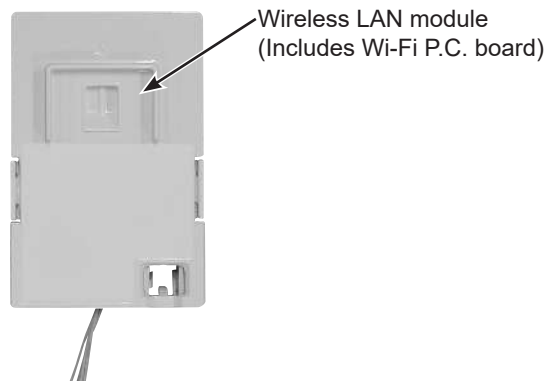

Photo 5



OPERATING PROCEDURE

3. Removing the indoor terminal P.C. board, the indoor electronic control P.C. board, the display P.C. board, switch P.C. board and the receiver P.C. board

- (1) Remove the panel (Refer to section 1), wireless LAN module, panel (F) and the right corner box.
- (2) Remove the indoor/outdoor connecting wire, electrical cover. (Refer to section 2)
- (3) Remove the ground wire connected to the indoor electronic control P.C. board from the electrical box.
- (4) Unhook the catch on the left side of the display P.C. board holder. Pull the display P.C. board holder as if opening the door at 90 degrees.
- (5) Open the rear cover of the display P.C. board holder and pull out the display P.C. board, the switch/buzzer P.C. board and the receiver P.C. board.
- (6) Disconnect the following connector (Photo 8):
<Indoor electronic control P.C. board>
CN110 (Wi-Fi assembly)
CN10A (Switch P.C. board, display P.C. board, receiver P.C. board)
CN211 (Indoor fan motor)
CN151 (Vane motors)
CN111 (Room temperature thermistor)
CN112 (Indoor coil thermistors)
CN147 (Refrigerant sensor (option))
- (7) Remove the screw of the terminal block on the indoor terminal P.C. board.
- (8) Remove the indoor terminal P.C. board and the indoor electronic control P.C. board.

How to install the refrigerant sensor (option) (Photo 7)

- (1) Connect the cable to the refrigerant sensor connector.
- (2) Put in the refrigerant sensor to the refrigerant sensor space.

4. Removing the indoor electrical box

- (1) Remove the panel (Refer to section 1), wireless LAN module, panel(F) and the right corner box.
- (2) Remove the indoor/outdoor connecting wire, electrical cover. (Refer to section 2)
- (3) Disconnect all the connectors on the indoor electronic control P.C. board and unhook all lead wires.
- (4) Unhook the catch on the left side of the display P.C. board holder. Pull the display P.C. board holder as if opening the door at 90 degrees. (Refer to section 3)
- (5) Remove the screw of the conduit cover and remove conduit cover.
- (6) Remove the screw of the conduit plate and remove the conduit plate.
- (7) Remove the screw fixing the electrical box, then the upper catch of the electrical box, and pull out the electrical box.

PHOTOS/FIGURES

Photo 6

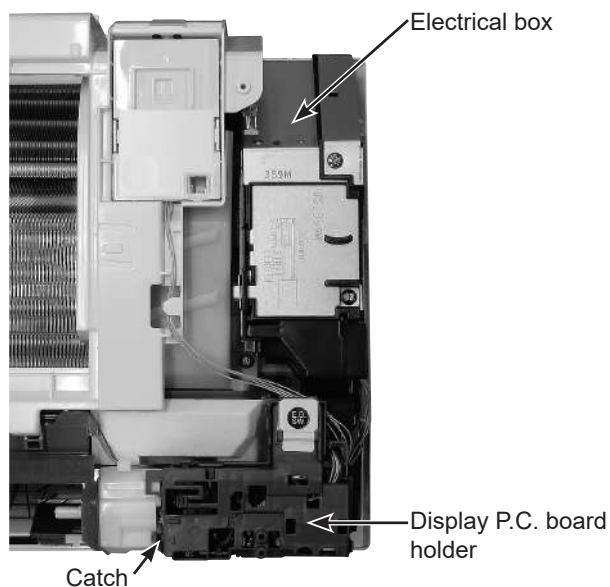

Photo 7

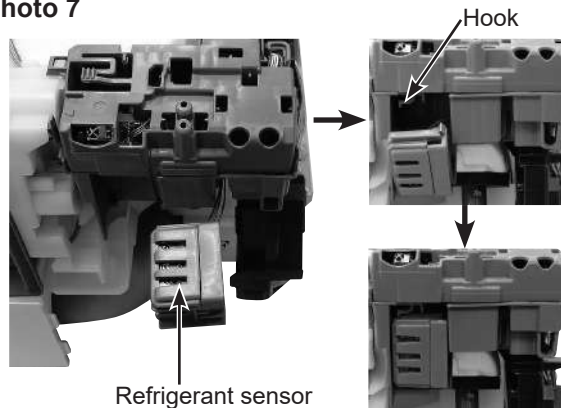
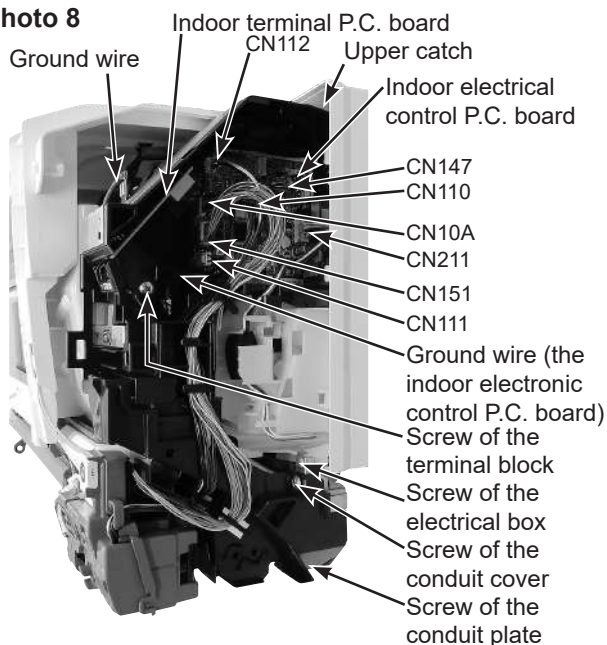
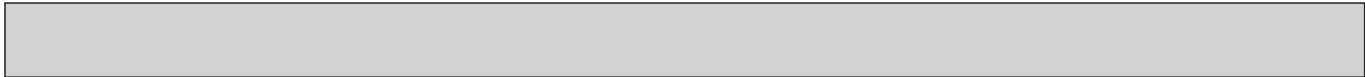

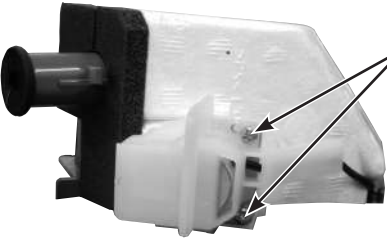
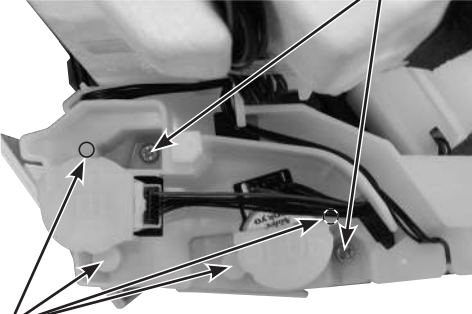

Photo 8





OPERATING PROCEDURE	PHOTOS/FIGURES
<p>5. Removing the nozzle assembly</p> <ol style="list-style-type: none">(1) Remove the panel (Refer to section 1), wireless LAN module, panel (F) and the right corner box.(2) Remove the indoor/outdoor connecting wire, electrical cover. (Refer to section 2)(3) Disconnect the following connectors on the electronic control P.C. board: CN151 (Horizontal vane motor)(4) Unhook the catch on the left side of the display P.C. board holder. Pull the display P.C. board holder as if opening the door at 90 degrees.(5) Pull out the drain hose from the nozzle assembly and remove the nozzle assembly.	<p>Photo 9</p>  <p>Screw of the vertical vane motor unit</p>
<p>6. Removing the vertical vane motor unit</p> <ol style="list-style-type: none">(1) Remove the nozzle assembly. (Refer to section 5)(2) Remove the crank of the vertical vane motor unit from the arm of the vertical vane.(3) Remove the screw of the vertical vane motor unit, and pull the vertical vane motor unit.(4) Remove the screws of the vertical vane motor unit cover.(5) Remove the crank of the vertical vane motor unit from the shaft of the vane motor.(6) Remove the vertical vane motor from the vertical vane motor unit.(7) Disconnect the connector of vertical vane motor from the vertical vane motor.	<p>Photo 10</p>  <p>Screws of the vertical vane motor unit cover</p>
<p>7. Removing the horizontal vane motor</p> <ol style="list-style-type: none">(1) Remove the nozzle assembly. (Refer to section 5)(2) Remove the screws of the horizontal vane motor unit, and pull out the horizontal vane motor unit.(3) Disconnect the connector from the horizontal vane motor.(4) Remove the screws of the horizontal vane motor unit cover.(5) Remove the horizontal vane motor from the horizontal vane motor unit.	<p>Photo 11</p>  <p>Screws of the vane motor unit</p> <p>Screws of the horizontal vane motor unit cover</p>

OPERATING PROCEDURE

8. Removing the water cut, the indoor fan motor, the indoor coil thermistor, and the line flow fan

- (1) Remove the panel (Refer to section 1), wireless LAN module, panel (F) and the right corner box.
- (2) Remove the display P.C. board holder, the electrical box and the nozzle assembly. (Refer to section 4 and 5)
- (3) Remove the screw of the water cut and remove the water cut.
- (4) Loosen the screw fixing the line flow fan.
- (5) Remove the screws fixing the motor bed.
- (6) Remove the motor bed together with fan motor and motor band.
- (7) Release the hooks of the motor band. Remove the motor band. Pull out the indoor fan motor.
- (8) Remove the indoor coil thermistor from the heat exchanger.
 - * Install the indoor coil thermistor in its former position when assembling it.
- (9) Remove the screws fixing the left side of the heat exchanger.
- (10) Lift the heat exchanger, and pull out the line flow fan to the lower-left.
 - * When attaching the line flow fan, screw the line flow fan so 5 mm gap is provided between the right end of the line flow fan and the right wall of the air passage of the box (Figure 1).

Figure 1

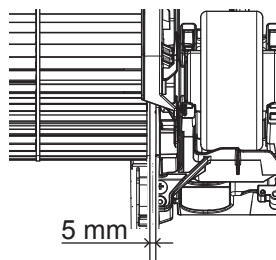
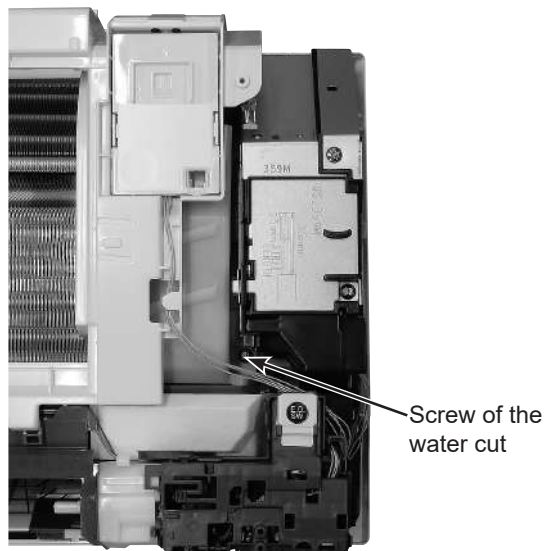

Photo 12



PHOTOS/FIGURES

Photo 13

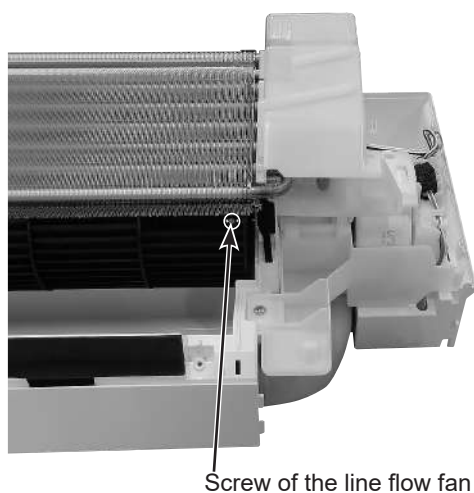

Photo 14

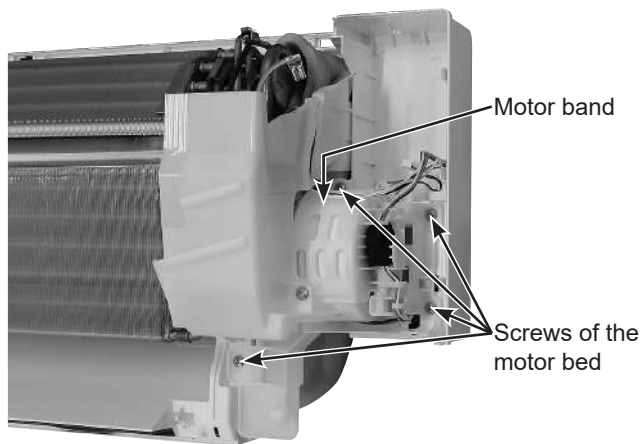
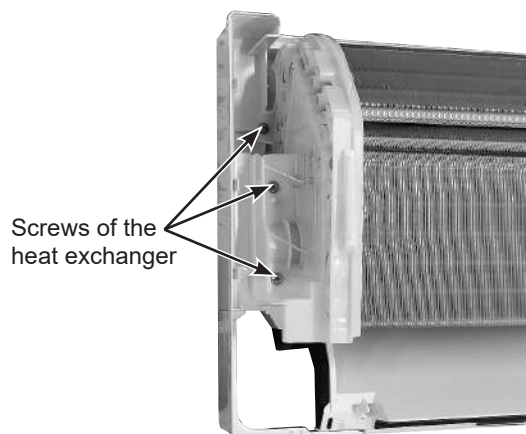

Photo 15



Fixing the indoor coil thermistor

*There are 2 forms of parts for fixing the indoor coil thermistor.

Clip shape



Holder shape



When fixing the indoor coil thermistor to the clip-shape/holder-shape part, the lead wire should point down.

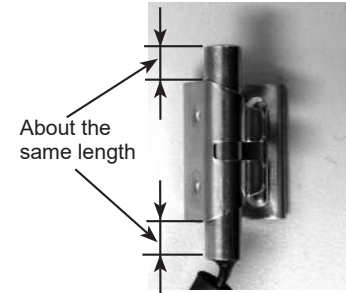

Position and procedure for mounting the clip-shape part

1. Set the indoor coil thermistor in the center of the clip-shape part.



2. Check the (marked) mounting position.



3. Mount the clip-shape part.



NOTE:

- Take care to avoid loss and accidental falling of the clip-shape part inside the unit.
- Mount the clip-shape part on the marked position.
- Do not pull the lead wire when removing the indoor coil thermistor.

mitsubishi electric corporation

HEAD OFFICE: TOKYO BUILDING, 2-7-3, MARUNOUCHI, CHIYODA-KU, TOKYO 100-8310, JAPAN

© Copyright 2024 MITSUBISHI ELECTRIC CORPORATION

Issued: Nov. 2024. No. OBH950 REVISED EDITION-A

Published: Oct. 2024. No. OBH950

Made in Japan

Specifications subject to change without notice.